



WE2021/A

yellow energy



Saldatrici **Welding equipment**

San Marino, il valore del tempo

San Marino, the value of time

Noi crediamo che senza storia non ci sia futuro e San Marino di storia ne ha parecchia da raccontare: nata il 3 Settembre 301d.C., ha visto nascere l'Italia molti anni dopo.

San Marino induce sensazioni di affidabilità e solidità, caratteristiche che si tramandano da secoli attraverso i suoi cittadini e si ritrovano oggi nelle aziende sammarinesi e nei loro prodotti, destinati a durare a lungo nel tempo.

Tecnologia e passione sono le fondamenta sulle quali Marino De Biagi ha costruito DECA nel 1972, portandola al successo attraverso l'innovazione, nel rispetto dell'ambiente e delle persone, indispensabili per la crescita di ogni azienda.

We believe that there is no future without history and San Marino has a lot to tell: founded on 3 September 301AD, it saw the birth of Italy many years after. San Marino inspires feelings of reliability and solidity, characteristics that have been handed on for ages through its citizens and now distinguish San Marino companies and products, which are bound to last for a long time.

Technology and passion are the foundations on which Marino De Biagi set up DECA in 1972, bringing it to success through innovation, while respecting the environment and people, who are essential for the growth of every company.

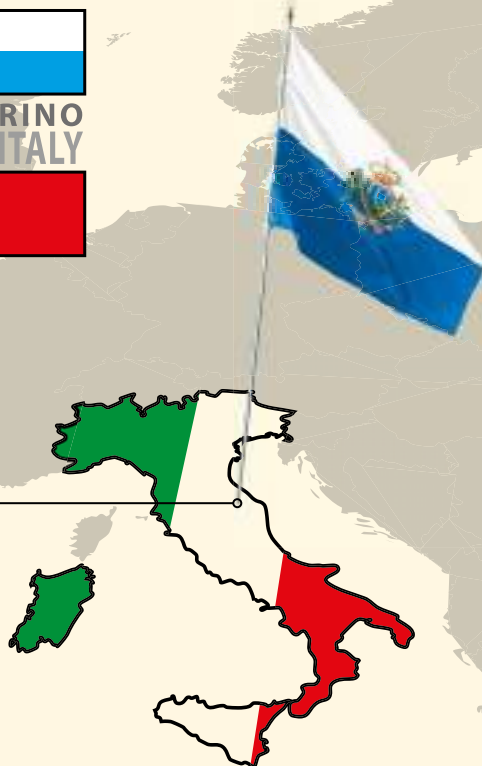

Storia di qualità e innovazione

Story of quality and innovation



La nostra vocazione per la cura di ogni dettaglio va oltre il prodotto: DECA investe per la tranquillità dei suoi clienti attraverso il rispetto delle direttive, seguendo rigorosamente le prescrizioni delle norme tecniche e certificando la qualità e la sicurezza dei prodotti tramite gli organismi più riconosciuti a livello internazionale.



Our inclination to the care of every detail goes beyond the product: DECA invests for its customers' peace of mind by complying with directives, strictly following the requirements of technical standards and certifying the quality and safety of products through the most internationally recognized organizations.



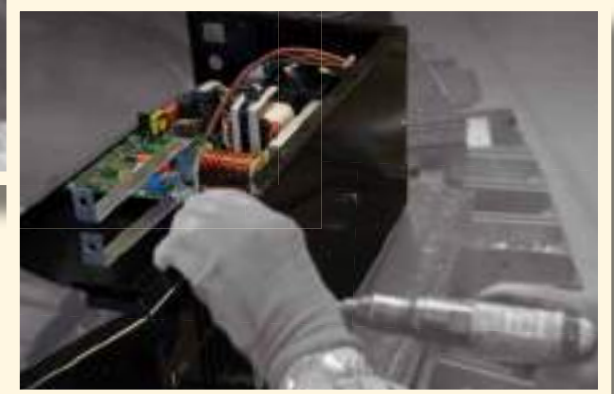
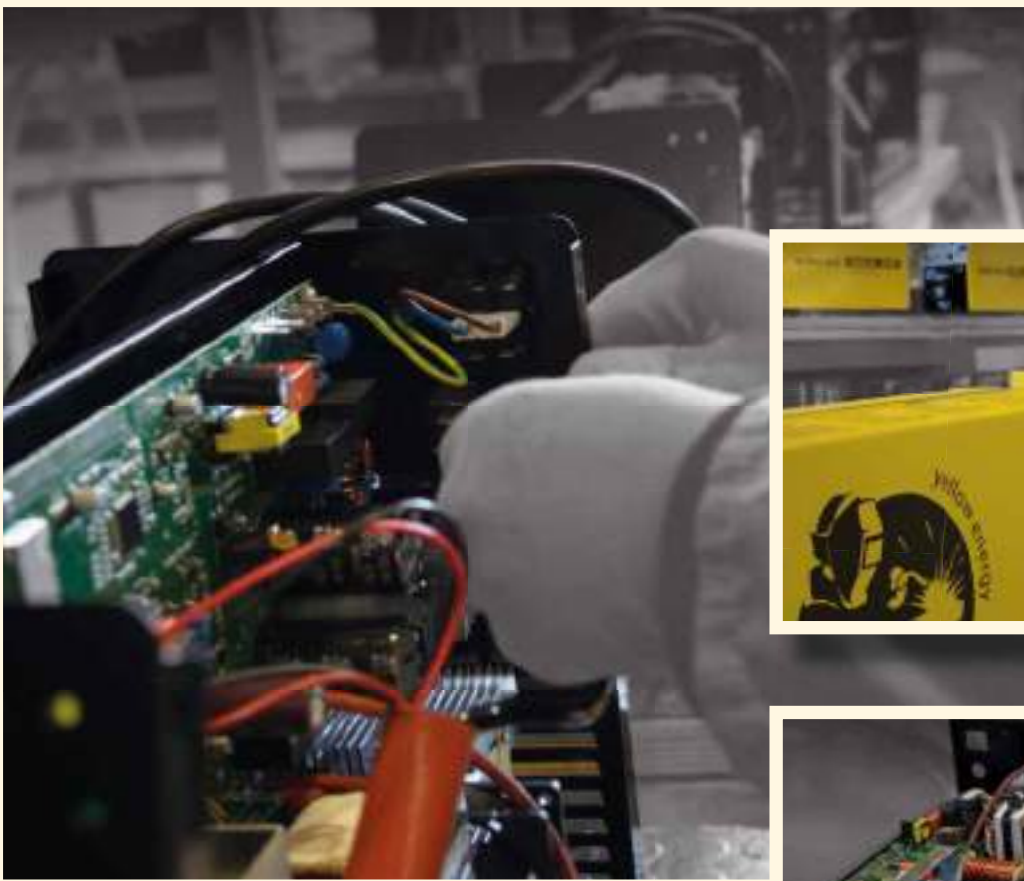

La formazione del nostro personale tecnico, di laboratorio e di assistenza dopo la vendita, è un'attività che ci impegna a fondo, con continuità, ed accresce il valore delle saldatrici e dei carica-batterie DECA.

We are fully and continuously committed to the training of our technical, laboratory and after-sales assistance staff, which increases the value of DECA welding machines and battery chargers.



La tecnologia riaccende la passione

Technology rekindles passion



DECA oggi è un marchio presente a livello internazionale, tutti i nostri prodotti sono progettati e realizzati con la massima cura nelle sedi sammarinesi e vengono sottoposti a controlli rigorosi prima della spedizione ai clienti.

Il nostro reparto di ricerca e sviluppo è formato da personale altamente qualificato, costantemente rivolto a sperimentare nuove soluzioni tecniche.

Ed è proprio l'urgenza di innovazione continua che ci ha indotto a creare il nuovo laboratorio d'élite **LAB**.

DECA is today an internationally recognized brand. All our products are designed and produced with the utmost care in the San Marino premises and are subjected to strict controls before being shipped to customers.

Our research and development department is made up of highly qualified personnel, constantly committed to experimenting with new technical solutions.

And the urgency of continuous innovation is precisely what led us to create our new elite laboratory **LAB**.



















Il piacere di Saldare The pleasure of Welding

Saldare per mestiere
Weld for work



UNA SCELTA ESCLUSIVA
AN EXCLUSIVE CHOICE

Car Body Repair

MMA	10		MMA
TIG	18		TIG
MIG	20		MIG
PAC	30		PAC
MMA	34		MMA
TIG	44		TIG
MIG	50		MIG
PAC	69		PAC
MIG - SPOT - DENT PULLER - STUD ALU	74	    	CAR BODY REPAIR
Accessori - Accessories	101		Accessori Accessories
Note tecniche / Technical tips	121		Tech

Il piacere di Saldare

The pleasure of Welding

Semplicemente DECA

DECA oggi è un marchio presente a livello internazionale, tutti i nostri prodotti sono progettati e realizzati con la massima cura nelle sedi sammarinesi e vengono sottoposti a controlli rigorosi prima della spedizione ai clienti.

Il nostro reparto di ricerca e sviluppo è formato da personale altamente qualificato, costantemente rivolto a sperimentare nuove soluzioni tecniche.

Simply DECA

DECA is today an internationally recognized brand. All our products are designed and produced with the utmost care in the San Marino premises and are subjected to strict controls before being shipped to customers.

Our research and development department is made up of highly qualified personnel, constantly committed to experimenting with new technical solutions





deca®

MMA INVERTER



Utilizzo leggero
Light duty

Manutenzione
Maintenance

- Compatte e maneggevoli
- Facili da usare
- Basso consumo energetico
- Elettrodi rutili, basici e TIG

- Compact and Handy
- Easy to use
- Low energy consumption
- Rutile, Basic electrode and TIG

NEW Promotion Pack 04/2021



** SIL 313-415-417 Promotion Pack

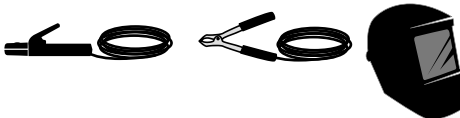

Auto Darkening
DIN 11



SIL è maneggevole, pratica, destinata alle piccole manutenzioni ma anche all'intervento d'emergenza professionale.
E' perfetta per gli spostamenti rapidi in furgone, sempre pronta all'uso in valigetta con i suoi accessori.

SIL is handy, practical, intended for small repair, as well as professional emergency interventions.
It is perfect for quick movements in the van, always ready for use in a suitcase with its accessories.



*Accessori in dotazione - Supplied accessories



010301

010310



MADE IN SAN MARINO		SIL 208	SIL 313	SIL 415	SIL 417
		MMA DC	MMA DC	MMA DC	MMA DC
Campo di regolazione - Welding current range		10 - 80A	10 - 130A	10 - 150A	10 - 170A
Servizio DECA 20°C - DECA use 20°C		80A - 50%	125A - 60%	150A - 60%	170A - 48%
Servizio 40°C - Duty cycle 40°C EN 60974-1		80A - 7%	125A - 7%	140A - 7%	160A - 8%
Tensione a vuoto - Open circuit voltage		85V		102V	
Tensione di alimentazione - Input voltage		1 ph - 230V 50/60 Hz			
Potenza assorbita - Absorbed power: 60% / Max		- / 2,2 kW	- / 3,4 kW	1,1 / 4,0 kW	1,5 / 4,9 kW
Fusibile - Fuse		16A			
Generatore - Generator		+/- 15% (3 kW)	+/- 15% (5 kW)	+/- 15% (6 kW)	+/- 15% (7 kW)
Elettrodi : Ø mm Electrodes: Ø mm	Rutile	1,6 - 2,5	1,6 - 3,2	1,6 - 4,0	1,6 - 4,0
	Basico - Basic	-	2,0 - 2,5	2,0 - 3,2	2,0 - 4,0
	TIG	-	-	1,6	1,6
Connessioni in uscita - Output connection		Cavi diretti - Direct cables		DX 25 mmq	
Protezione termostatica - Thermostatic Protection		●	●	●	●
Peso - Weight ≈		2,9 kg	2,6 kg	3,6 kg	
Dimensioni - Dimensions		293 x 132 x 206 mm		335 x 132 x 206 mm	
Versione - Version					
*Generatore + accessori - *Power source + accessories		279280	279380	279780	279880
** Promotion Pack		-	279391	279791	279891
Accessori - Accessories MMA pag. 108 TIG pag. 110					

Funzioni - Features	SIL 208	SIL 313	SIL 415	SIL 417
Hot start	●	●	●	●
Anti-sticking	●	●	●	●
Arc force	●	●	●	●
TIG	-	-	Scratch	Scratch

Optionals SIL 415 - 417

NEW 010061 KIT TIG TG9
Ø 1,6 WR2 acciaio-steel
(pag. 110)



110A - 3 m



MMA

TIG

MIG

PAC

MMA

TIG

MIG

PAC

CAR BODY REPAIR

Accessori Accessories

Tech



Utilizzo leggero
Light duty

Manutenzione
Maintenance

- Compatte e maneggevoli
- Facili da usare
- Basso consumo energetico
- Elettrodi rutili, basici e TIG

- Compact and Handy
- Easy to use
- Low energy consumption
- Rutile, Basic electrode and TIG

SIL 417 GEN

- SPECIALE GENERATORE
GENERATOR USE

SILTIG 415

- DISPLAY DIGITALE
DIGITAL DISPLAY
- ARC FORCE e HOT START
REGOLABILI
ARC FORCE e HOT START
ADJUSTABLE
- TIG DC LIFT

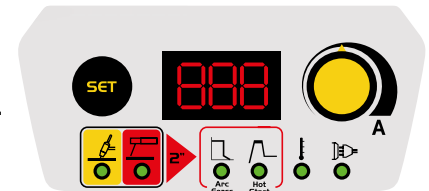

*SIL 417 GEN Accessori in dotazione - Supplied accessories



*SILTIG 415 Accessori in dotazione - Supplied accessories

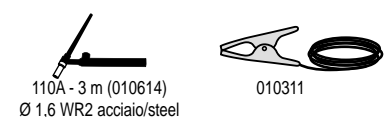



MADE IN SAN MARINO		SIL 417 GEN		SILTIG 415	
		MMA DC		MMA DC	
Campo di regolazione - Welding current range		10 - 170A		10 - 150A	
Servizio DECA 20°C - DECA use 20°C		170A - 48%		150A - 60%	
Servizio 40°C - Duty cycle 40°C EN 60974-1		160A - 8%		140A - 7%	
Tensione a vuoto - Open circuit voltage				102V	
Tensione di alimentazione - Input voltage				1 ph - 230V 50/60 Hz	
Potenza assorbita - Absorbed power: 60% / Max		1,5 / 4,9 kW		1,1 / 4,0 kW	
Fusibile - Fuse				16A	
Generatore - Generator		+/- 30% (7 kW)		+/- 15% (6 kW)	
Elettrodi : Ø mm Electrodes: Ø mm	Rutile	1,6 - 4,0		1,6 - 4,0	
	Basico - Basic	2,0 - 4,0		2,0 - 3,2	
	TIG	1,6		-	
Connessioni in uscita - Output connection				DX 25 mmq	
Protezione termostatica - Thermostatic Protection		●		●	
Peso - Weight =				3,6 kg	
Dimensioni - Dimensions				335 x 132 x 206 mm	
Versione - Version					
*Generatore + accessori - *Power source + accessories		278980		279180	
Accessori - Accessories MMA pag. 108 TIG pag. 110					

Funzioni - Features		MMA DC	TIG DC
Hot start	●	Regolabile - Adjustable	
Anti-sticking	●		●
Arc force	●	Regolabile - Adjustable	
TIG	Scratch		Lift

Optionals SIL 417 GEN

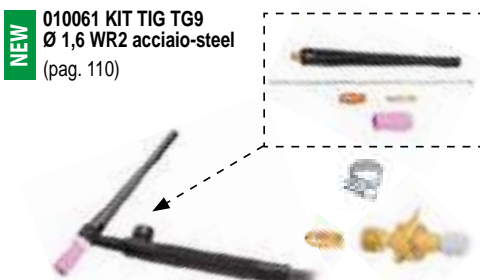

NEW 010061 KIT TIG TG9
Ø 1,6 WR2 acciaio-steel
(pag. 110)

110A - 3 m

Optionals SILTIG 415

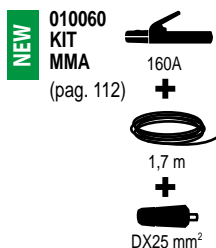

NEW 010060
KIT
MMA 160A
(pag. 112)

1,7 m
+
DX25 mm²

010571 CO₂ → Ar



010499 CO₂

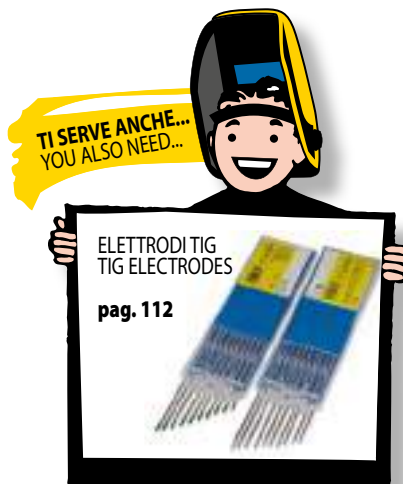

MMA

TIG

MIG

PAC

MMA

TIG

MIG

PAC

CAR BODY REPAIR

Accessori Accessories

Tech

i-ARC Heavy Duty

DC
-+

MMA INVERTER

NEW



Manutenzione
Maintenance
Carpenteria leggera
Light carpentry
Cantiere edile
Construction site

- Cicli di lavoro elevato
- Compatte e maneggevoli
- Basso consumo energetico
- Elettrodi rutili, basici e TIG
- Heavy duty cycle
- Compact and Handy
- Low energy consumption
- Rutile, Basic electrode and TIG

i-ARC 217 GEN

- **SPECIALE GENERATORE**
GENERATOR USE

i-ARC 216D

- **DISPLAY DIGITALE**
DIGITAL DISPLAY
- **ARC FORCE e HOT START**
REGOLABILI
ARC FORCE e HOT START
ADJUSTABLE
- **TIG DC LIFT**

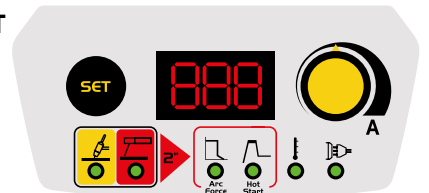

Promotion Pack 04/2021



** i-ARC 217 Promotion Pack



i-ARC 2 è una gamma di inverter professionali per il lavoro in officina, in cantiere e per tutte le applicazioni che richiedono qualità di esecuzione. Potenti e affidabili, sono saldatrici che non deludono chi le usa.

i-ARC 2 is a range of professional inverters for the workshop, for the construction site and for all applications that require quality of execution. Powerful and reliable, they are welding machines that do not disappoint those who use them.



*Accessori in dotazione - Supplied accessories



010303
16 mm² 1,7 m



010311
16 mm² 1,7 m



MADE IN SAN MARINO		i-ARC 215	i-ARC 216D		i-ARC 217 GEN
		MMA DC	MMA DC	TIG DC	MMA DC
Campo di regolazione - Welding current range		10 - 150A	10 - 160A	10 - 160A	10 - 170A
Servizio DECA 20°C - DECA use 20°C		150A - 60%	160A - 60%	-	170A - 60%
Servizio 40°C - Duty cycle 40°C EN 60974-1		150A - 25%	160A - 20%	160A - 25%	170A - 20%
Tensione a vuoto - Open circuit voltage		88V			
Tensione di alimentazione - Input voltage		1 ph - 230V 50/60 Hz			
Potenza assorbita - Absorbed power: 60% / Max		2,8 / 4,0 kW	2,8 / 4,8 kW		2,8 / 4,9 kW
Fusibile - Fuse		16A			
Generatore - Generator		+/- 15% (6kW)	+/- 15% (7 kW)		+/- 30% (7 kW)
Elettrodi : ø mm Electrodes: ø mm	Rutile	1,6 - 4,0	1,6 - 4,0	-	1,6 - 4,0
	Basico - Basic	2,0 - 3,2	2,0 - 3,2	-	2,0 - 4,0
	TIG	1,0 - 4,0	-	1,0 - 4,0	1,0 - 4,0
Connessioni in uscita - Output connection		DX 25 mmq			
Protezione termostatica - Thermostatic Protection		●	●		●
Peso - Weight ≈		4 kg			
Dimensioni - Dimensions		370 x 134 x 206 mm			
Versione - Version					
*Generatore + accessori - *Power source + accessories		285680	286480		285780
** Promotion Pack		-	-		285791
Accessori - Accessories MMA pag. 108 TIG pag. 110					

Funzioni - Features		MMA DC	TIG DC	
Hot start	●	Regolabile - Adjustable	-	●
Anti-sticking	●	●	-	●
Arc force	●	Regolabile - Adjustable	-	●
TIG	Scratch	-	Lift	Scratch

Optionals i-ARC 215 - 216D - 217

NEW

010068 KIT TIG TG17
Ø 1,6 WR2 acciaio-steel
(pag. 110)



140A - 4 m

010571 CO₂ → Ar



010499 CO₂



**TI SERVE ANCHE...
YOU ALSO NEED...**



MMA

TIG

MIG

PAC

MMA

TIG

MIG

PAC

CAR BODY REPAIR

Accessori Accessories

Tech



Utilizzo leggero
Light duty
Carpenteria leggera
Light carpentry
Cantiere edile
Construction site

- Robuste e durevoli
 - Carrozzeria resistente
 - Elettrodi rutili
-
- Sturdy and durable
 - Tough housing
 - Rutile electrodes



GLOBUS è la gamma di saldatrici economiche ideali per moltissime applicazioni con elettrodi rutili, destinata alle piccole manutenzioni e nella piccola officina. La semplicità d'uso è notevole.

GLOBUS is the range of economical welding machines ideal for many applications with rutile electrodes, for small repair and small workshops. Its simplicity of use is remarkable.

*GLOBUS MINI, 3.0, 4.0, 4.2 Accessori in dotazione - Supplied accessories



010301

010310

*GLOBUS 4.2, 5.0D Accessori in dotazione - Supplied accessories



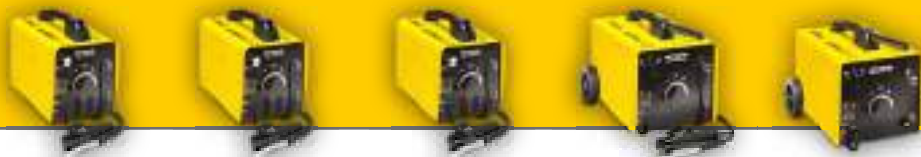

MADE IN SAN MARINO		GLOBUS MINI	GLOBUS 3.0	GLOBUS 4.0	GLOBUS 4.2	GLOBUS 5.0 D
		MMA AC	MMA AC	MMA AC	MMA AC	MMA AC
Campo di regolazione - Welding current range		44 - 140A	44 - 140A	44 - 160A	35 - 160A	30 - 200A
Tensione a vuoto - Open circuit voltage		43 - 49V			39 - 49V	41 - 50V
Tensione di alimentazione - Input voltage		1 ph - 230V 50/60 Hz			1 ph - 230/400V 50/60 Hz	
Potenza assorbita - Absorbed power: Min / Max		2,0 - 4,0 kW	2,0 - 4,0 kW	2,0 - 5,0 kW	2,0 - 5,0 kW	2,0 - 6,0 kW
Fusibile - Fuse		16A		20A	20/16A	25/20A
Elettrodi : ø mm Electrodes: ø mm	Rutile	1,6 - 3,2	1,6 - 3,2	1,6 - 4,0	1,6 - 4,0	1,6 - 5,0
Connessioni in uscita - Output connection		Cavi diretti - Direct cables				DX 25 mmq
Ventilata - Fan cooled		—	•	•	•	•
Regolazione continua - Stepless regulation		•	•	•	•	•
Protezione termostatica - Thermostatic Protection		•	•	•	•	•
Peso - Weight ≈		13,7 kg	13,9 kg	15,6 kg	17 kg	19,1 kg
Dimensioni - Dimensions		390 x 210 x 280 mm			570 x 320 x 350 mm	
Versione - Version						
*Generatore + accessori - *Power source + accessories		204100	204500	204700	204900	—
Solo generatore - Power source only		—	—	—	—	203700
Accessori - Accessories MMA pag. 108						

MMA

TIG

MIG

PAC

MMA

TIG

MIG

PAC

CAR BODY
REPAIRAccessori
Accessories

Tech

Optional GLOBUS MINI - 3.0 - 4.0

010272
Kit ruote
Kit wheels

Optional GLOBUS 5.0 D

000201
Kit MMA DS/16
(pag. 108)TI SERVE ANCHE...
YOU ALSO NEED...



Manutenzione
Maintenance

Carpenteria leggera
Light carpentry

Autoriparazioni
Automotive

Saldatura di precisione
Precision welding

- Carrozzeria resistente
 - Compatte e maneggevoli
 - Facili da usare
 - TIG con innescò HF o LIFT
 - Elettrodi rutili, basici
-
- Tough housing
 - Compact and Handy
 - Easy to use
 - TIG with HF or LIFT arc striking
 - Rutile, Basic electrodes

- SPECIALE GENERATORE
- GENERATOR USE

CONVAIR COOLING SYSTEM



- VENTILAZIONE AD ALTE PRESTAZIONI
- HIGH PERFORMANCE VENTILATION

EASY PULSE

- Regolazione automatica della corrente base e della frequenza di pulsazione in funzione della corrente di picco impostata. Semplifica il procedimento di saldatura.
- Automatic regulation of the base current and the pulsation frequency according to the set peak current. It simplifies the welding process.

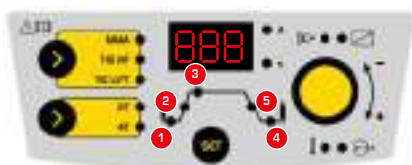

i-TIG 318

- 1 PREGAS** : Regolazione del tempo di pre-gas.
- 2 SLOPE-UP**: Regolazione del tempo con cui la corrente di saldatura si porta dal valore iniziale (innescò dell'arco) al valore principale "I (Amp)".
- 3 I (Amp)**: Regolazione della corrente principale di saldatura.
- 4 SLOPE-DOWN**: Tempo con cui, dopo il rilascio del pulsante torcia, la corrente di saldatura si porta dal valore principale al valore finale (termine della saldatura).
- 5 POSTGAS**: Regolazione del tempo di post-gas.
- 6 PULSE (Hz)**: Nella modalità "TIG PULSE" varia la frequenza di pulsazione.

3 + 6 i-TIG 320

TEMPO DI SALDATURA: Regolazione della durata del tempo di saldatura a punti

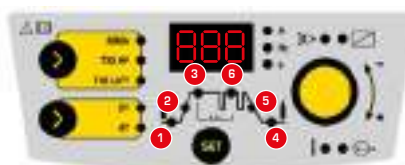

i-TIG 320

- 1 PREGAS**: Pre-gas time adjustment.
- 2 SLOPE-UP**: Adjustment of time at which the welding current is brought from the initial value (arc start) to the main value "I (Amp)".
- 3 I (Amp)**: Main welding current adjustment.
- 4 SLOPE-DOWN**: Time at which, once the torch button is released, the welding current is brought from the main value to the final value (end of welding).
- 5 POSTGAS**: Post-gas time adjustment.
- 6 PULSE (Hz)**: In the "TIG PULSE" mode, it varies the pulse frequency.

3 + 6 i-TIG 320

SPOT WELDING TIME: Spot welding time adjustment

*Accessori in dotazione - Supplied accessories

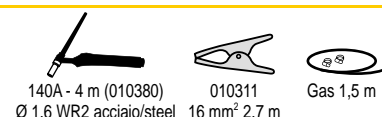



MADE IN SAN MARINO		i-TIG 318		i-TIG 320	
		MMA DC	TIG DC	MMA DC	TIG DC
Campo di regolazione - Welding current range		10 - 160A	10 - 180A	10 - 180A	10 - 200A
Servizio 40°C - Duty cycle 40°C EN 60974-1		160A - 30%	180A - 30%	180A - 20%	200A - 20%
		130A - 60%	140A - 60%	130A - 60%	140A - 60%
Tensione a vuoto - Open circuit voltage		90V		90V	
Tensione di alimentazione - Input voltage		1 ph - 230V 50/60 Hz		1 ph - 230V 50/60 Hz	
Potenza assorbita - Absorbed power: 60% / Max		3,3 / 4,8 kW		3,3 / 5,4 kW	
Fusibile - Fuse		25A		25A	
Generatore - Generator		+/- 30% (7 kW)		+/- 30% (7 kW)	
Elettrodi : ø mm Electrodes: ø mm	Rutile - Rutile Basico - Basic	1,6 - 4,0	-	1,6 - 4,0	-
	TIG	-	1,0 - 4,0	-	1,0 - 4,0
Connessioni in uscita - Output connection		DX 25 mmq			
Ventilata - Fan cooled		Convair Cooling System			
Protezione termostatica - Thermostatic Protection		●			
Peso - Weight ≈		6,7 kg			
Dimensioni - Dimensions		428 x 160 x 274 mm			
Versione - Version					
*Generatore + accessori - *Power source + accessories		286100		286300	
Accessori - Accessories MMA pag. 108 TIG pag. 110					

Funzioni - Features	MMA DC	TIG DC	MMA DC	TIG DC
TIG HF - Lift	-	●	-	●
Easy Pulse	-	-	-	●
Frequenza DC - DC Frequency	-	-	-	0,2 - 250 Hz
Pregas - Postgas	-	Regolabile - Adjustable	-	Regolabile - Adjustable
Slope Up - Slope Down	-	Regolabile - Adjustable	-	Regolabile - Adjustable
2T - 4T	-	●	-	●
Spot	-	-	-	Regolabile - Adjustable
Arc force	●	-	●	-
Hot start / Anti-sticking	●	-	●	-

Optionals i-TIG 318 - 320

NEW

010072 KIT STARTER Ø 2,4 acciaio-steel
(pag. 110)

1x Ø 2,4 WR2

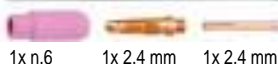

1x n.6 1x 2,4 mm 1x 2,4 mm

NEW

010069 KIT MMA
(pag. 112)

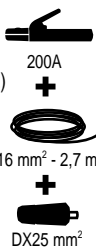

200A
+
16 mm² - 2,7 m
+
DX25 mm²

010571 CO₂ → Ar



010242 CO₂



010378
9 m



010890
Carrello CR26
CR26 Trolley



**TI SERVE ANCHE...
YOU ALSO NEED...**

**ELETTRODI TIG
TIG ELECTRODES**
pag. 112

MMA

TIG

MIG

PAC

MMA

TIG

MIG

PAC

CAR BODY
REPAIR

Accessori
Accessories

Tech

MULTIPROCESS INVERTER



- SPECIALE GENERATORE
- GENERATOR USE

Utilizzo leggero
Light duty

Manutenzione
Maintenance

Carpenteria leggera
Light carpentry

Autoriparazioni
Automotive

- 4 volte utile: salda a filo con gas, a filo senza gas, ad elettrodo ed in TIG
 - Impianti multiprocesso ad alta qualità di saldatura
 - Induttanza, Arc Force e Slope down regolabili
 - Compatti e maneggevoli
 - Facili da usare grazie alla regolazione sinergica dei parametri di saldatura
- 4 times useful: it welds welding wire with gas, welding wire without gas, coated electrode and TIG
 - Multiprocess welders with high quality welding
 - Adjustable inductance, Arc Force, Slope down
 - Compact and Handy
 - Easy to use thanks to the synergic adjustment of the welding parameters



5 kg MAX



TRAINAFILO ROBUSTO D. 25
ROBUST WIRE FEEDER D. 25

NEW



010827

Filo animato Ø 0,6 mm per saldare senza gas lamiere sottili

Self shielded wire Ø 0,6 mm for welding on thin sheets without gas

decca
MIGA: la nuova gamma di generatori a tecnologia inverter controllati a microprocessore per saldatura MIG/MAG, a filo NO GAS, MMA e TIG DC. La grande versatilità e la semplicità d'uso rendono queste saldatrici idonee ad un numero elevato di applicazioni: manutenzioni di vario genere, piccole costruzioni, officina.

decca
MIGA: the new range of inverter technology power sources controlled by microprocessor for MIG/MAG, NO-GAS wire, MMA and TIG DC welding. The great versatility and ease of use make these welding machines suitable for a large number of applications: various types of maintenance, small constructions, workshops.

*MIGA 215 Accessori in dotazione - Supplied accessories



110A - 2 m (010821)



010310



Gas 1,5 m



Ø 0,9 Flux / 0,6 Fe (011250)



Animato
Self-shielded Ø 0,9 mm



MADE IN SAN MARINO		MIGA 215		
		MIG	MMA	TIG
Campo di regolazione - Welding current range		10 - 150A	10 - 130A	10 - 150A
Servizio - Duty cycle 40°C EN 60974-1		110A - 25%	100A - 25%	110A - 25%
		70A - 60%	60A - 60%	70A - 60%
Tensione a vuoto - Open circuit voltage		100V		
Tensione di alimentazione - Input voltage		1 ph - 230V - 50/60 Hz		
Potenza assorbita - Absorbed power: 60% / Max		1,6 / 2,5 kW		
Fusibile - Fuse		16A		
Generatore - Generator		+/- 30% (4 kW)		
Modalità MIG - MIG Mode		MANUAL / SYNERGIC		
Filo \varnothing mm Wire \varnothing mm	Acciaio - Steel	0,6 - 0,8 - 0,9		
	Inox - Stainless steel	0,8		
	Al.Mg / Al.Si	0,8 - 1,0		
	Cu.Si 3 / Cu.Al 8	0,8		
	Filo animato - Flux cored	0,8 - 0,9 - 1,0		
Bobina \varnothing mm - Wire spool \varnothing mm		100 - 200		
Elettrodi : \varnothing mm Electrodes: \varnothing mm	Rutile / Basico Rutile / Basic	1,6 - 3,2		
	TIG	1,0 - 2,4		
Trainafilo - Wire feeder		2 rulli - 2 rollers		
Connessioni in uscita - Output connection		DX 25 mmq / Torcia diretta - Direct torch		
Protezione temostatica - Thermostatic Protection		●		
Peso - Weight ≈		9,7 kg		
Dimensioni - Dimensions		452 x 220 x 345 mm		
Versione - Version				
*Generatore + accessori		241800		
Accessori - Accessories MMA pag. 108 - TIG pag. 110 - MIG pag. 113				

Funzioni - Features	MIG MAG / NO GAS	MMA	TIG
Saldatura sinergica - Synergic welding	●		
Induttanza elettronica - Electronic inductor	Regolabile Adjustable		
Burn Back	●		
Hot Start	●	●	
Arc Force		Regolabile Adjustable	
Anti-sticking		●	●
Tig Lift (Torcia con rubinetto - Torch with gas valve)			●
Slope Up			●
Slope Down			Regolabile Adjustable

Optionals MIGA 215

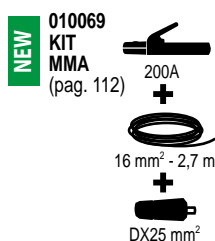
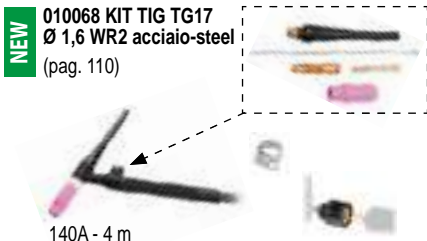

010571 CO₂ → Ar



010499 CO₂



010823
 Carrello CRMI
 CRMI Trolley

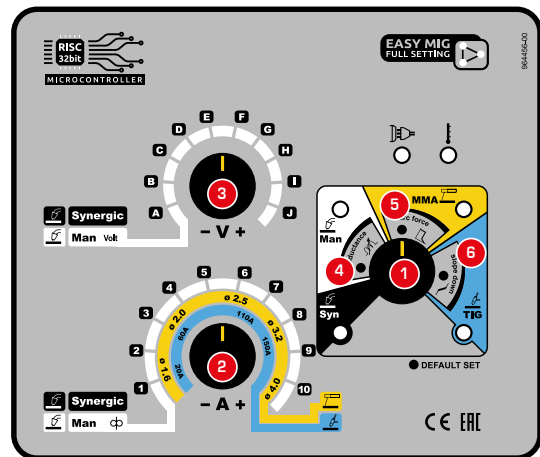

- Selezione processo di saldatura**
 - Syn: saldatura a filo in modalità Sinergica
 - Man: saldatura a filo in modalità Manuale
 - MMA: saldatura ad elettrodo
 - TIG: saldatura TIG DC Lift
 - Regolazione corrente di saldatura (Ampere)**
 - Syn: posizionare il potenziometro sul numero della corona in base al programma sinergico scelto
 - Man: regolazione velocità filo
 - MMA: regolazione corrente (corona gialla)
 - TIG: regolazione corrente (corona blu)
 - Regolazione tensione di saldatura (Volt)**
 - Syn: posizionare il potenziometro sulla lettera della corona in base al programma sinergico scelto
 - Man: regolazione tensione d'arco
 - Regolazione elettronica induttanza in saldatura a filo manuale**
 - Regolazione ARC FORCE in saldatura ad elettrodo**
 - Regolazione rampa di discesa (Slope Down) in saldatura TIG**
- Welding process selection**
 - Syn: wire welding in Synergic mode
 - Man: wire welding in Manual mode
 - MMA: electrode welding
 - TIG: TIG DC Lift welding
 - Welding current regulation (Amp)**
 - Syn: set the potentiometer on the number corresponding to the synergic program
 - Man: wire speed adjustment
 - MMA: current adjustment (yellow scale)
 - TIG: current adjustment (blue scale)
 - Welding voltage adjustment (Volt)**
 - Syn: place the potentiometer on the letter corresponding to the synergic program
 - Man: arc voltage regulation
 - Electronic inductance adjustment in manual wire welding**
 - ARC FORCE adjustment in electrode welding**
 - Slope Down adjustment in TIG welding**

MMA

TIG

MIG

PAC

MMA

TIG

MIG

PAC

CAR BODY REPAIR

Accessori
Accessories

Tech

MULTIPROCESS INVERTER



Utilizzo leggero
Light duty

Manutenzione
Maintenance

Carpenteria leggera
Light carpentry

Autoriparazioni
Automotive

- 4 volte utile: salda a filo con gas, a filo senza gas, ad elettrodo ed in TIG
 - Impianti multiprocesso ad alta qualità di saldatura
 - Induttanza, Arc Force e Slope down regolabili
 - Compatti e maneggevoli
 - Facili da usare grazie alla regolazione sinergica dei parametri di saldatura
- 4 times useful: it welds welding wire with gas, welding wire without gas, coated electrode and TIG
 - Multiprocess welders with high quality welding
 - Adjustable inductance, Arc Force, Slope down
 - Compact and Handy
 - Easy to use thanks to the synergic adjustment of the welding parameters

- SPECIALE GENERATORE
- GENERATOR USE

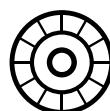

5 kg MAX



TRAINAFILO ROBUSTO D. 25
ROBUST WIRE FEEDER D. 25

NEW



010827

Filo animato Ø 0,6 mm per saldare senza gas lamiere sottili

Self shielded wire Ø 0,6 mm for welding on thin sheets without gas

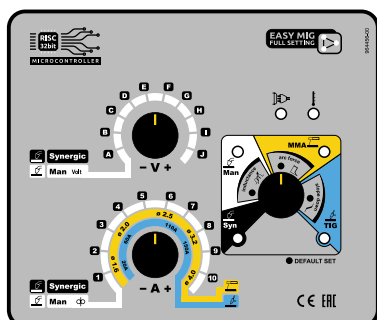

(pag. 21)

*MIGA 218 - 220 Accessori in dotazione - Supplied accessories

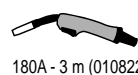

180A - 3 m (010822)



010311
16 mm² - 2 m



Gas 1,5 m



A Ø 0,8 / 1,0 Fe
(011251)



MADE IN SAN MARINO		MIGA 218			MIGA 220		
		MIG	MMA	TIG	MIG	MMA	TIG
Campo di regolazione - Welding current range		10 - 180A	10 - 150A	10 - 180A	10 - 200A	10 - 160A	10 - 200A
Servizio - Duty cycle 40°C EN 60974-1		140A - 25%	120A - 25%	140A - 25%	180A - 25%	150A - 25%	180A - 25%
		90A - 60%	85A - 60%	90A - 60%	100A - 60%	100A - 60%	100A - 60%
Tensione a vuoto - Open circuit voltage		86V			86V		
Tensione di alimentazione - Input voltage		1 ph - 230V - 50/60 Hz			1 ph - 230V - 50/60 Hz		
Potenza assorbita - Absorbed power: 60% / Max		2,2 / 3,5 kW			2,8 / 5 kW		
Fusibile - Fuse		16A			20A		
Generatore - Generator		+/- 30% (5 kW)			+/- 30% (7 kW)		
Modalità MIG - MIG Mode		MANUAL / SYNERGIC			MANUAL / SYNERGIC		
Filo ø mm Wire ø mm	Acciaio - Steel	0,6 - 0,8 - 0,9			0,6 - 0,8 - 0,9 - 1,0		
	Inox - Stainless steel	0,8			0,8 - 1,0		
	Al.Mg / Al.Si	0,8 - 1,0			0,8 - 1,0 - 1,2		
	Cu.Si 3 / Cu.Al 8	0,8			0,8 - 1,0		
	Filo animato - Flux cored	0,8 - 0,9 - 1,0 - 1,2			0,8 - 0,9 - 1,0 - 1,2		
Bobina ø mm - Wire spool ø mm		100 - 200					
Elettrodi : ø mm Electrodes: ø mm	Rutile / Basico Rutile / Basic	1,6 - 3,2			1,6 - 4,0		
	TIG	1,0 - 4,0			1,0 - 4,0		
Trainafilo - Wire feeder		2 rulli - 2 rollers			2 rulli - 2 rollers		
Connessioni in uscita - Output connection		DX 25 mmq / Torch Euro			DX 25 mmq / Torch Euro		
Protezione temostatica - Thermostatic Protection		●			●		
Peso - Weight ≈		9,5 kg			10 kg		
Dimensioni - Dimensions		452 x 220 x 345 mm			452 x 220 x 345 mm		
Versione - Version							
Generatore + accessori		241900			242000		
Accessori - Accessories MMA pag. 108 - TIG pag. 110 - MIG pag. 113							

Funzioni - Features	MIG MAG / NO GAS	MMA	TIG
Saldatura sinergica - Synergic welding	●		
Induttanza elettronica - Electronic inductor	Regolabile - Adjustable		
Burn Back	●		
Hot Start	●	●	
Arc Force		Regolabile - Adjustable	
Anti-sticking		●	●
Tig Lift (Torcia con rubinetto - Torch with gas valve)			●
Slope Up			●
Slope Down			Regolabile - Adjustable

Optionals MIGA 218-220

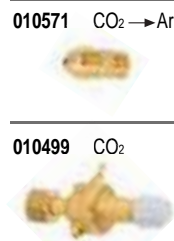
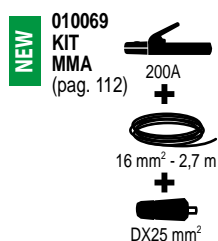
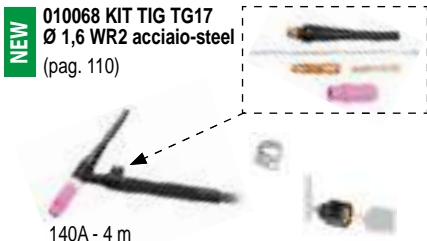

010823
Carrello CRMI
CRMI Trolley

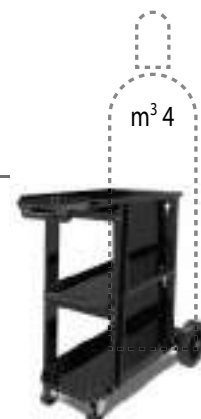

MMA

TIG

MIG

PAC

MMA

TIG

MIG

PAC

CAR BODY
REPAIR

Accessori
Accessories

Tech

MULTIPROCESS INVERTER

NEW



Manutenzione
Maintenance
Carpenteria leggera
Light carpentry
Autoriparazioni
Automotive

- 4 volte utile: salda a filo con gas, a filo senza gas, ad elettrodo ed in TIG
 - Impianti multiprocesso ad alta qualità di saldatura
 - Induttanza, Arc Force e Slope down regolabili
 - Utilizza bobine di filo fino a 15Kg
 - Facili da usare grazie alla regolazione sinergica dei parametri di saldatura
- 4 times useful: it weld welding wire with gas, welding wire without gas, coated electrode and TIG
 - Multiprocess welders with high quality welding
 - Adjustable inductance, Arc Force, Splope down
 - Uses wire spools up to 15Kg
 - Easy to use thanks to the synergic adjustment of the welding parameters

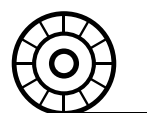

15 kg MAX



TRAINAFILO ROBUSTO D. 30
ROBUST WIRE FEEDER D. 30

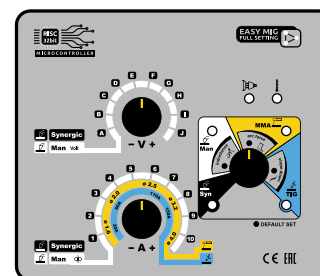

(pag. 21)

* MIGA 225 XL - 380 Accessori in dotazione - Supplied accessories



180A - 3 m (010822)



010311
16 mm² - 2,7 m



Gas 1,5 m



B
Ø 0,6 / 0,8 Fe
(011214)



MADE IN SAN MARINO	MIGA 225 XL			MIGA 380		
	MIG	MMA	TIG	MIG	MMA	TIG
Campo di regolazione - Welding current range	10 - 200A	10 - 160A	10 - 200A	10 - 200A	10 - 160A	10 - 200A
Servizio - Duty cycle 40°C EN 60974-1	180A - 25%	150A - 25%	180A - 25%	180A - 25%	150A - 25%	180A - 25%
	100A - 60%	100A - 60%	100A - 60%	100A - 60%	100A - 60%	100A - 60%
Tensione a vuoto - Open circuit voltage	86V			86V		
Tensione di alimentazione - Input voltage	1 ph - 230V - 50/60 Hz			1 ph - 230V - 50/60 Hz		
Potenza assorbita - Absorbed power: 60% / Max	2,8 / 5 kW			2,8 / 5 kW		
Fusibile - Fuse	20A			20A		
Generatore - Generator	+/- 30% (7 kW)			+/- 30% (7 kW)		
Modalità MIG - MIG Mode	MANUAL / SYNERGIC			MANUAL / SYNERGIC		
Filo ø mm Wires ø mm	Acciaio - Steel	0,6 - 0,8 - 0,9 - 1,0		0,6 - 0,8 - 0,9 - 1,0		
	Inox	0,8 - 1,0		0,8 - 1,0		
	Al.Mg / Al.Si	0,8 - 1,0 - 1,2		0,8 - 1,0 - 1,2		
	Cu.Si 3 / Cu.Al 8	0,8 - 1,0		0,8 - 1,0		
	Filo animato - Flux cored	0,8 - 0,9 - 1,0 - 1,2		0,8 - 0,9 - 1,0 - 1,2		
Bobina ø mm - Wire spool ø mm	200 - 300					
Elettrodi : ø mm Electrodes: ø mm	Rutile / Basico Rutile / Basic	1,6 - 4,0		1,6 - 4,0		
	TIG	1,0 - 4,0		1,0 - 4,0		
Trainafilo - Wire feeder	2 rulli - 2 rollers			2 rulli - 2 rollers		
Connessioni in uscita - Output connection	DX 25 mmq / Euro			DX 25 mmq / Euro		
Protezione termostatica - Thermostatic Protection	●			●		
Peso - Weight ≈	14,6 kg			30 kg		
Dimensioni - Dimensions	555 x 276 x 425 mm			775 x 400 x 790 mm		
Versione - Version	242100			242300		
*Generatore + accessori - *Power source + accessories	242100			242300		

Accessori - Accessories MMA pag. 108 - TIG pag. 110 - MIG pag. 113

Funzioni - Features	MIG MAG / NO GAS	MMA	TIG
Saldatura sinergica - Synergic welding	●	-	-
Induttanza elettronica - Electronic inductor	Regolabile - Adjustable	-	-
Burn Back	●	-	-
Hot Start	●	●	-
Arc Force	-	Regolabile - Adjustable	-
Anti-sticking	-	●	●
Tig Lift (Torch con rubinetto - TIG torch with gas valve)	-	-	●
Slope Up	-	-	●
Slope Down	-	-	Regolabile - Adjustable

Optionals MIGA 380

Ø 100

010251
Aspo
Spool holder



Optionals MIGA 225XL

010823
Carrello CRMI
CRMI Trolley



Optionals MIGA 225XL - 380

NEW

010068 KIT TIG TG17
Ø 1,6 WR2 acciaio-steel
(pag. 110)

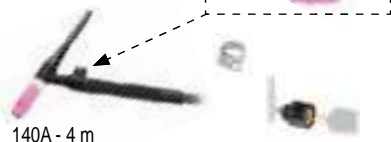

140A - 4 m

NEW

010069
KIT
MMA
(pag. 112)



16 mm² - 2,7 m

DX25 mm²

010571 CO₂ → Ar



010499 CO₂



m³ 4

MMA

TIG

MIG

PAC

MMA

TIG

MIG

PAC

CAR BODY
REPAIR

Accessori
Accessories

Tech

D-mig 2

MIG TRADITIONAL

**MIG MAG
NO GAS**



Utilizzo leggero
Light duty

Manutenzione
Maintenance

Carpenteria leggera
Light carpentry

- Saldano a filo con gas ed a filo senza gas
- Compatte e maneggevoli
- Facili da usare
- Tabella di aiuto alla corretta regolazione dei parametri di saldatura
- Weld welding wire with gas and welding wire without gas
- Compact and Handy
- Easy to use
- Help table for the correct adjustment of the welding parameters

D-mig 230 AC

- NO GAS ONLY

0,8 kg MAX



5 kg MAX



La gamma classica DECA per le piccole riparazioni e per manutenzione professionale su piccoli spessori. Idonea anche per saldatura con filo animato NO GAS.

The DECA classic range for small repair and professional maintenance on small thicknesses.
Also suitable for NO GAS cored wire welding.

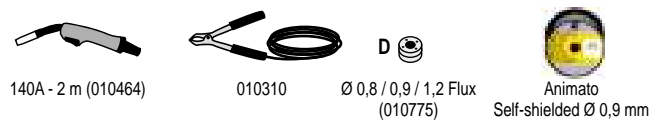
***D-mig 230 AC Accessori in dotazione - Supplied accessories**



***D-mig 235 - 265 Accessori in dotazione - Supplied accessories**

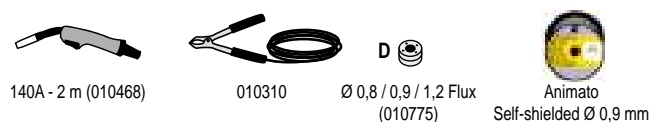



MADE IN SAN MARINO		D-mig 230 AC	D-mig 235	D-mig 265
		NO GAS	MIG-MAG / NO GAS	MIG-MAG / NO GAS
Campo di regolazione - Welding current range		90 - 130A	32 - 120A	35 - 145A
Posizioni di saldatura - Welding positions		2	4	
Servizio 40° C - Duty cycle 40° C EN 60974-1		80A - 20%	100A - 15%	105A - 14%
		40A - 90%	55A - 60%	55A - 60%
Tensione a vuoto - Open circuit voltage		18 - 22V	31 - 49V	31 - 49V
Tensione di alimentazione - Input voltage		1 ph - 230V 50/60 Hz		
Potenza assorbita - Absorbed power: 60% / Max		Min. 1,2 / Max 2,3 kW	1,2 / 2,2 kW	1,2 / 2,4 kW
Fusibile - Fuse		16A		
Filo ø mm Wires ø mm	Acciaio - Steel	-	0,6 - 0,8	0,6 - 0,8
	Inox	-	0,8	0,8
	Al.Mg - Al.Si	-	0,8 - 1,0	0,8 - 1,0
	Filo animato - Flux cored	0,9	0,9	0,9
Bobina Ø mm - Wire spool Ø mm		100	100 - 200	
Trainafilo - Wire feeder		2 rulli - 2 rollers		
Connessioni in uscita - Output connection		diretto - direct		
Ventilata - Fan cooled		-	•	•
Protezione termostatica - Thermostatic Protection		•	•	•
Peso - Weight =		14 kg	21 kg	21,5 kg
Dimensioni - Dimensions		330 x 170 x 330 mm	420 x 230 x 380 mm	
Versione - Version				
*Generatore + accessori - *Power source + accessories		241300	241400	241500
Accessori - Accessories MIG pag. 113				

Optional D-mig 235 - 265

010515 CO₂



		mm	1,0	1,5	2,0	3,0	4,0
Fe	0,9 Flux		Min 3-5	Min 4-7	Min 5-8	Min 7-10	Max 7-10

D-mig 230 AC



		mm	0,8	1,0	1,5	2,0	3,0	4,0	5,0
Fe	Ar/CO ₂	0,6	Min1 7-8	Max1 8-10	Min2 8-10	Max2 8-10			
		0,8	Min1 8-10	Max1 7-9	Min2 7-9	Max2 9-10	Max2 9-10	Max2 9-10	Max2 9-10
Al	Argon	0,8			Min1 8-10	Max1 8-10	Min2 8-10		
		1,0			Min1 7-9	Max1 6-8	Min2 8-10	Max2 8-10	
Fe	x Flux	0,9	Min1 3-5	Min1 4-7	Max1 5-8	Min2 5-7	Max2 5-8	Max2 8-10	

D-mig 235



		mm	0,8	1,0	1,5	2,0	3,0	4,0	5,0
Fe	Ar/CO ₂	0,6	Min1 4-6	Max1 6-8	Min2 7-9	Max2 6-8	Max2 8-10		
		0,8	Min1 6-8	Max1 7-9	Min2 7-10	Max2 7-10	Min2 8-10	Max2 8-10	Max2 8-10
Al	Argon	0,8			Min1 8-9	Max1 8-10	Min2 8-10	Max2 8-10	
		1,0			Min1 8-10	Max1 8-10	Min2 8-10	Max2 8-10	
Fe	x Flux	0,9	Min1 6-8	Min1 7-9	Max1 5-7	Min2 7-9	Max2 7-9	Min2 8-10	Max2 8-10

D-mig 265

**TI SERVE ANCHE...
YOU ALSO NEED...**

VUOI SALDARE CON IL GAS?
DO YOU WANT TO WELD
WITH GAS?

pag. 118

MMA
TIG
MIG
PAC
MMA
TIG
MIG
PAC
CAR BODY REPAIR
Accessories
Tech

D-mig 3-4

MIG TRADITIONAL

MIG MAG
NO GAS

MIG MAG



Utilizzo leggero
Light duty

Manutenzione
Maintenance

Carpenteria leggera
Light carpentry

Autoriparazioni
Automotive

- Saldano a filo con gas ed a filo senza gas
 - Compatte e maneggevoli
 - Facili da usare
 - Tabella di aiuto alla corretta regolazione dei parametri di saldatura
-
- Weld welding wire with gas and welding wire without gas
 - Compact and Handy
 - Easy to use
 - Help table for the correct adjustment of the welding parameters

D-mig 420S

- BOBINA Ø 200 / 300
WIRE SPOOL Ø 200 / 300



5 kg MAX

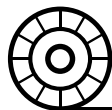

5 kg MAX

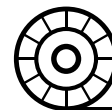

15 kg MAX

*D-mig 350 - 380 Accessori in dotazione - Supplied accessories



160A - 2 m (010470)



010311
16 mm² - 2 m



Adattatore bombole
Bottle adapter



Ø 0,8 / 0,9 / 1,2 Flux
(010775)
Ø 0,6 Fe (010776)



Animato
Self-shielded Ø 0,9 mm

*D-mig 390 Accessori in dotazione - Supplied accessories



180A - 3 m (010234)



010311
16 mm² - 2 m



Adattatore bombole
Bottle adapter



Ø 0,8 / 0,9 / 1,2 Flux
(010775)
Ø 0,6 Fe (010776)
Ø 0,8 / 1,0 Fe/Al
(010673)



Animato
Self-shielded Ø 0,9 mm

*D-mig 420S Accessori in dotazione - Supplied accessories



180A - 3 m (010234)



010311
16 mm² - 2 m



Gas 1,5 m



Ø 0,6 Fe (010776)
Ø 0,8 / 1,0 Fe/Al
(010673)



MADE IN SAN MARINO		D-mig 350	D-mig 380	D-mig 390	D-mig 420 S
		MIG MAG / NO GAS	MIG MAG / NO GAS	MIG MAG / NO GAS	MIG MAG
Campo di regolazione - Welding current range		35 - 145A	35 - 160A	35 - 200A	35 - 200A
Posizioni di saldatura - Welding positions		4	6		
Servizio 40°C - Duty cycle 40°C EN 60974-1		115A - 15%	130A - 10%	165A - 15%	165A - 15%
		60A - 60%	65A - 60%	80A - 60%	80A - 60%
Tensione a vuoto - Open circuit voltage		31 - 49V	30 - 54V	29 - 52V	29 - 52V
Tensione di alimentazione - Input voltage		1 ph - 230V 50/60 Hz			
Potenza assorbita - Absorbed power: 60% / Max		1,4 / 2,7 kW	1,5 / 3,1 kW	1,8 / 4,3 kW	
Fusibile - Fuse		16A		20A	
Filo ø mm Wires ø mm	Acciaio - Steel	0,6 - 0,8	0,6 - 0,8	0,6 - 0,8 - 1,0	0,6 - 0,8 - 1,0
	Inox	0,8	0,8	0,8	0,8
	Al.Mg - Al.Si	0,8 - 1,0	0,8 - 1,0	0,8 - 1,0	0,8 - 1,0
	Filo animato - Flux cored	0,9	0,9	0,9	-
Bobina Ø mm - Wire spool Ø mm		100 - 200			200 - 300
Trainafilo - Wire feeder		2 rulli - 2 rollers			
Connessioni in uscita - Output connection		diretto - direct		diretto - direct / Euro	
Elettrovalvola gas - Gas solenoid valve		-		•	
Protezione termostatica - Thermostatic Protection		•	•	•	•
Peso - Weight ≈		29 kg	31,5 kg	38 kg	41 kg
Dimensioni - Dimensions		720 x 360 x 490 mm			705 x 410 x 465 mm
Versione - Version					
*Generatore + accessori - *Power source + accessories		254400	254500	255200	255000
Accessori - Accessories MIG pag. 113					

Optionals D-mig 420S

Ø 100

010251
Aspo
Spool holder



Optionals D-mig 350 - 380 - 390 - 420S

010571 CO₂ → Ar 010499 CO₂



—	Φ	mm	0,8		1,0		1,5		2,0		3,0		4,0		5,0		
			Min1	Max1	Min2	Max2	Min1	Max1	Min2	Max2	Min1	Max1	Min2	Max2	Min1	Max1	Min2
Fe	Ar/Co ₂	0,6	4-6	6-8	7-9	6-8	8-10										
		0,8	6-8	7-9	7-10	7-10	8-10										
Al	Argon	0,8			8-9	8-10	8-10	8-10									
		1,0			8-10	8-10	8-10	8-10									
Fe	X Flux	0,9	6-8	7-9	5-7	7-9	7-9	7-9	8-10	8-10							

D-mig 350



—	Φ	mm	0,8		1,0		1,5		2,0		3,0		4,0		5,0		>5,0	
			Min1	Max1	Min2	Max2	Min1	Max1	Min2	Max2	Min1	Max1	Min2	Max2	Min1	Max1	Min2	Max2
Fe	Ar/Co ₂	0,6	5-7	7-9	8-10	8-10	8-10	8-10	8-10	8-10								
		0,8	5-8	5-8	8-10	7-9	7-10	7-10	7-10	7-10	8-10	8-10						
Al	Argon	0,8			8-10	9-10	9-10	9-10	9-10	9-10								
		1,0			8-10	9-10	9-10	9-10	9-10									
Fe	X Flux	0,9	4-6	5-8	6-9	5-8	7-10	7-10	7-10	7-10	8-10	8-10	8-10	8-10	8-10	8-10	8-10	8-10

D-mig 380



—	Φ	mm	0,8		1,0		1,5		2,0		3,0		4,0		5,0		>5,0	
			Min1	Max1	Min2	Max2	Min1	Max1	Min2	Max2	Min1	Max1	Min2	Max2	Min1	Max1	Min2	Max2
Fe	Ar/Co ₂	0,6	5-7	7-9	8-10	8-10	8-10	8-10	8-10	8-10								
		0,8	5-7	7-9	6-8	7-9	8-10	8-10	8-10	8-10	8-10	8-10						
Al	Argon	0,8			8-10	9-10	9-10	9-10	9-10	9-10								
		1,0			7-9	8-10	8-10	8-10	8-10									
Fe	X Flux	0,9	4-6	5-7	6-8	7-9	7-9	7-9	7-9	8-10	8-10	8-10	8-10	8-10	8-10	8-10	8-10	8-10

D-mig 390

**TI SERVE ANCHE...
YOU ALSO NEED...**

BOBINA FILO 5 KG.
5 KG. WIRE SPOOL

pag. 107

MMA

TIG

MIG

PAC

MMA

TIG

MIG

PAC

CAR BODY REPAIR

Accessori Accessories

Tech

I-PAC 340-335K

PAC INVERTER

NEW



Manutenzione
Maintenance

Carpenteria leggera
Light carpentry

Autoriparazioni
Automotive

- Taglio plasma ad inverter con arco stabile ed ottima capacità di taglio
 - Taglio su grigliato
 - Arco pilota
 - Carrozzeria resistente
 - Compatte e maneggevoli
- Inverter plasma cutter with stable cutting arc and excellent cutting capacity
 - Cut on grid
 - Pilot arc
 - Tough housing
 - Compact and Handy

I-PAC 340

- RIDUTTORE DI PRESSIONE
- PRESSURE REDUCER



INCLUDED!

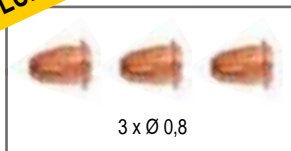

- VENTILAZIONE AD ALTE PRESTAZIONI
- HIGH PERFORMANCE VENTILATION
- SPECIALE GENERATORE
- GENERATOR USE

CONVAIR COOLING SYSTEM



I-PAC 335K

- COMPRESSORE INTEGRATO
- COMPRESSOR INSIDE
- SPECIALE GENERATORE
- GENERATOR USE

INCLUDED!



I-PAC è la soluzione ideale per l'officina auto e per la carpenteria leggera. Il modello con compressore d'aria integrato nella sorgente è particolarmente indicato per gli interventi fuori sede.

I-PAC is the ideal solution for car workshops and light carpentry. The model with air compressor integrated in the source is particularly suitable for off-site operations.

*I-PAC 340 Accessori in dotazione - Supplied accessories

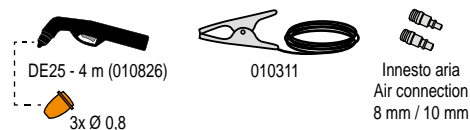

*I-PAC 335K Accessori in dotazione - Supplied accessories

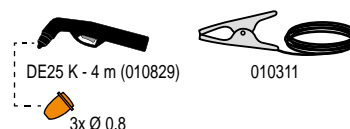



MADE IN SAN MARINO		I-PAC 340	I-PAC 335 K
Corrente di taglio - Cutting current		5 - 35A	5 - 35A
Servizio 40°C - Duty cycle 40°C EN 60974-1		35A - 30%	35A - 30%
		25A - 60%	25A - 60%
		20A - 100%	20A - 100%
Tensione a vuoto - Open circuit voltage	410V		
Tensione di alimentazione - Input voltage	1 ph - 230V - 50/60 Hz		
Potenza assorbita - Absorbed power: 60% / Max	2,7 / 3,9 kW		
Fusibile - Fuse	16A		
Generatore - Generator	+/- 30% (6kW)		
Taglio / Separazione* - Cut / Separation*	8 / 12 mm	6 / 12 mm	
Pressione aria min/max - Air pressure min/max	3,5 - 5,0 bar	Compressore integrato - Built in Compressor	
Consumo aria - Air consumption	115 lt/min	-	
Connettore torcia - Torch connection	Diretto - Direct		
Connettore massa - Earth connection	DX 25 mmq		
Compressore integrato - Built in Compressor	-	•	
Protezione termostatica - Thermostatic Protection	•	•	
Peso - Weight	6,7 kg	16 kg	
Dimensioni - Dimensions	480 x 160 x 273 mm	480 x 227 x 373 mm	
Versione - Version			
*Generatore + accessori - *Power source + accessories	111000	115100	
Accessori - Accessories PAC pag. 119			

Funzioni - Features

Taglio grigliato - Cut on grid	•	•
Arco pilota - Pilot arc	•	•
Ventilata - Fan cooled	Convair Cooling System	
Allerta alimentazione - Power indicator light	•	•
Sistema di sicurezza torcia - Safety torch	•	•



* Taglio / Cut



* Separazione / Separation

Optionals I-PAC 340 - I-PAC 335 K

NEW

010082 KIT STARTER
(pag.119)

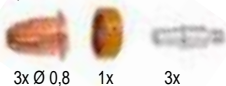

010889
Carrello CR28
CR28 Trolley



**TI SERVE ANCHE...
YOU ALSO NEED...**

UGELLO
ELETTRODO
NOZZLE
ELECTRODE

pag. 119



MMA

TIG

MIG

PAC

MMA

TIG

MIG

PAC

CAR BODY
REPAIR

Accessori
Accessories

Tech

Saldare per mestiere

Weld for work

LAB è il laboratorio d'eccellenza creato in DECA nel 2015.

Fedeli al credo che solo con le persone migliori si ottengono i risultati migliori, abbiamo selezionato con cura progettisti elettronici, meccanici, softwaristi, esperti di marketing, design ed ergonomia dei prodotti.

Ognuno di loro ha trovato una collocazione ideale all'interno del nuovo spazio LAB, condividendo esperienza, passione, motivazione e ricerca della perfezione.

Ogni progetto LAB viene curato nei minimi dettagli, deve superare test più severi di quanto prevedano le attuali normative di prodotto, deve essere assolutamente sicuro per le persone e realizzato nel rispetto dell'ambiente. Ma soprattutto deve garantire prestazioni di massimo livello.

LAB incuriosisce, sorprende, convince, entusiasma ed emoziona.

LAB is a laboratory of excellence created in DECA in 2015.

Faithful to the belief that the best results are achieved only with the best people, we carefully selected electronic, mechanic and software designers, and marketing, design and product ergonomics experts.

Each of them found an ideal location within the new space LAB, sharing experience, passion, motivation and the pursuit of perfection.

Each LAB project is developed in the smallest details; it must pass stricter tests than the current product regulations establish, must be absolutely safe for the people and be implemented respecting the environment. Above all, it must ensure top level performance.

LAB intrigues, surprises, convinces, enraptures and excites.





**UNA SCELTA ESCLUSIVA
AN EXCLUSIVE CHOICE**



Manutenzione
Maintenance

Carpenteria leggera
Light carpentry

Cantiere edile
Construction site

Carpenteria pesante
Heavy carpentry

- Carrozzeria resistente
- Compatta e maneggevoli
- Elettrodi rutili, basici e TIG

- Tough housing
- Compact and Handy
- Rutile, Basic electrodes and TIG

CONVAIR COOLING SYSTEM



- SPECIALE GENERATORE
- GENERATOR USE

- VENTILAZIONE AD ALTE PRESTAZIONI
- HIGH PERFORMANCE VENTILATION



i-ARC 3 rappresenta il TOP di gamma delle saldatrici monofase per elettrodi rivestiti. Rispondono a tutte le esigenze professionali e specialistiche di saldatura e sono garantite dal marchio d'eccellenza LAB.

i-ARC 3 represents the TOP of the range of single-phase welding machines for coated electrodes. They meet all professional and specialist welding needs and they are guaranteed by the LAB excellence brand..



*Accessori in dotazione - Supplied accessories



010303
25 mm² 2,3 m



010311
25 mm² 1,7 m



MADE IN SAN MARINO		i-ARC 318 LAB	i-ARC 320 LAB
		MMA DC	MMA DC
Campo di regolazione - Welding current range		10 - 180A	10 - 200A
Servizio DECA 20°C - DECA use 20°C		180A - 67%	200A - 60%
Servizio 40°C - Duty cycle 40°C EN 60974-1		160A - 80%	160A - 80%
Tensione a vuoto - Open circuit voltage		180A - 20%	200A - 15%
		130A - 60%	130A - 60%
Tensione di alimentazione - Input voltage		1 ph - 230V 50/60 Hz	
Potenza assorbita - Absorbed power: 60% / Max		3,3 / 5,4 kW	3,3 / 6,5 kW
Fusibile - Fuse		25A	
Generatore - Generator		+/- 30% (7 kW)	+/- 30% (8 kW)
Elettrodi : Ø mm Electrodes: Ø mm	Rutile	1,6 - 4,0	1,6 - 5,0
	Basico - Basic	2,0 - 4,0	2,0 - 5,0
	TIG	1,0 - 4,0	1,0 - 4,0
Connessioni in uscita - Output connection		DX 25 mmq	
Protezione termostatica - Thermostatic Protection		●	●
Peso - Weight ≈		5,3 kg	5,3 kg
Dimensioni - Dimensions		365 x 160 x 273 mm	
Versione - Version			
*Generatore + accessori - *Power source + accessories		285880	285980
Solo generatore - Power source only		285800	285900
Accessori - Accessories MMA pag. 108 TIG pag. 110			

Funzioni - Features		
Ventilata - Fan cooled	Convair Cooling System	
Hot start	●	●
Anti-sticking	●	●
Arc force	●	●
TIG	Scratch	Scratch

Optionals i-ARC 318 LAB - 320 LAB

000217
Kit MMA DS20
(pag. 108)



25 mm² - 3 m 25 mm² - 2 m DX25 mm²

NEW

010072 KIT STARTER Ø 2,4 acciaio-steel
(pag. 111)

1x Ø 2,4 WR2
1x n.6 1x 2,4 mm 1x 2,4 mm

NEW

010068 KIT TIG TG17
Ø 1,6 WR2 acciaio-steel
(pag. 110)



140A - 4 m

010571 CO₂ → Ar



010499 CO₂



**TI SERVE ANCHE...
YOU ALSO NEED...**

**POSIZIONATORE MAGNETICO
MAGNETIC POSITION HOLDER**

pag. 109

MMA

TIG

MIG

PAC

MMA

TIG

MIG

PAC

CAR BODY
REPAIR

Accessori
Accessories

Tech

i-ARC 319C LAB Cellulosic

DC
-+

MMA INVERTER

MODEL 2021



- Elettrodi CELLULOSICI / ALLUMINIO
- CELLULOSIC / ALUMINUM ELECTRODES

- SPECIALE GENERATORE
- GENERATOR USE



- VENTILAZIONE AD ALTE PRESTAZIONI
- HIGH PERFORMANCE VENTILATION

Manutenzione
Maintenance

Carpenteria leggera
Light carpentry

Cantiere edile
Construction site

Carpenteria pesante
Heavy carpentry

- Top di gamma per innesco, potenza e stabilità d'arco
- Carrozzeria resistente
- Compatta e maneggevole
- Elettrodi rutili, basilici, cellulosici, alluminio e TIG LIFT

- Top of range for arc striking power and arc stability
- Tough housing
- Compact and Handy
- Rutile, Basic, cellulosic, aluminum electrodes and TIG LIFT

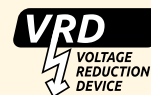

- Riduce la tensione di uscita per una migliore sicurezza nelle operazioni di saldatura

- Reduces the output voltage for better safety in welding operations



*Accessori in dotazione - Supplied accessories



010303
25 mm² 2,3 m



010311
25 mm² 1,7 m



MADE IN SAN MARINO		i-ARC 319C LAB	
		MMA DC	TIG DC
Campo di regolazione - Welding current range		10 - 180A	10 - 200A
Servizio DECA 20°C - DECA use 20°C		180A - 67%	-
		160A - 80%	-
Servizio 40°C - Duty cycle 40°C EN 60974-1		180A - 20%	200A - 20%
		130A - 60%	140A - 60%
Tensione a vuoto - Open circuit voltage		105V	
Tensione di alimentazione - Input voltage		1 ph - 230V 50/60 Hz	
Potenza assorbita - Absorbed power: 60% / Max		3,3 / 5,6 kW	
Fusibile - Fuse		25A	
Generatore - Generator		+/- 30% (7 kW)	
Elettrodi : Ø mm Electrodes: Ø mm	Rutile	1,6 - 4,0	-
	Basico - Basic	2,0 - 4,0	-
	Cellulosico Cellulosic	2,5 - 3,2	-
	Alluminio - Aluminum	2,5 - 3,2	-
	TIG	-	1,0 - 4,0
Connessioni in uscita - Output connection		DX 25 mmq	
Protezione termostatica - Thermostatic Protection		●	
Peso - Weight ≈		5,6 kg	
Dimensioni - Dimensions		365 x 160 x 273 mm	
Versione - Version			
*Generatore + accessori - *Power source + accessories		286280	
Solo generatore - Power source only		286200	
Accessori - Accessories MMA pag. 108 TIG pag. 110			

Funzioni - Features	MMA DC	TIG DC
Ventilata - Fan cooled	Convair Cooling System	
Hot start	●	-
Anti-sticking	●	-
Arc force	Regolabile - Adjustable	-
TIG	-	Lift

Optionals i-ARC 319C LAB

000217
Kit MMA DS20
(pag. 108)



25 mm² - 3 m 25 mm² - 2 m DX25 mm²

NEW **010072 KIT STARTER Ø 2,4 acciaio-steel**
(pag. 111)

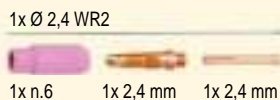

1x Ø 2,4 WR2
1x n.6 1x 2,4 mm 1x 2,4 mm

NEW **010068 KIT TIG TG17**
Ø 1,6 WR2 acciaio-steel
(pag. 110)



140A - 4 m

010571 CO₂ → Ar



010499 CO₂



**TI SERVE ANCHE...
YOU ALSO NEED...**

**ELETTRODI
ELECTRODES**

pag. 106

MMA

TIG

MIG

PAC

MMA

TIG

MIG

PAC

CAR BODY
REPAIR

Accessori
Accessories

Tech

i-ARC 525 LAB 3Ph

DC
-+

MMA INVERTER

NEW 03/2021



Manutenzione
Maintenance

Carpenteria leggera
Light carpentry

Cantiere edile
Construction site

Carpenteria pesante
Heavy carpentry

- Alimentazione trifase
- Top di gamma per innescò, potenza e stabilità d'arco
- Elettrodi rutili, basici e TIG LIFT
- Three-phase power supply
- Top of range for arc striking power and arc stability
- Rutile, Basic, and TIG LIFT

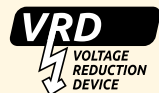

- Riduce la tensione di uscita per una migliore sicurezza nelle operazioni di saldatura
- Reduces the output voltage for better safety in welding operations

- SPECIALE GENERATORE
- GENERATOR USE

- CONNETTORI DX50 mm2
- DX50 mm2 CONNECTORS

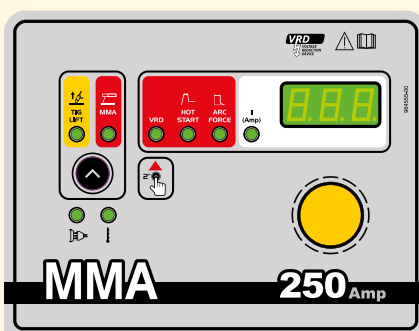



MADE IN SAN MARINO		i-ARC 525 LAB	
		MMA DC	TIG DC
Campo di regolazione - Welding current range		10 - 250A	10 - 250A
Servizio 40°C - Duty cycle 40°C EN 60974-1		230A - 25%	230A - 25%
		150A - 60%	160A - 60%
Tensione a vuoto - Open circuit voltage		85V	
Tensione di alimentazione - Input voltage		3 ph - 400V 50/60 Hz	
Potenza assorbita - Absorbed power: 60% / Max		4 / 8,0 kW	
Fusibile - Fuse		10A	
Generatore - Generator		+/- 30% (12 kW)	
Elettrodi : Ø mm Electrodes: Ø mm	Rutile	1,6 - 5,0	-
	Basico - Basic	1,6 - 5,0	-
	TIG	-	1,0 - 4,0
Connessioni in uscita - Output connection		DX 50 mmq	
Protezione termostatica - Thermostatic Protection		●	
Peso - Weight ≈		8,5 kg	
Dimensioni - Dimensions		450 x 200 x 365 mm	
Versione - Version			
Solo generatore - Power source only		286600	
Accessori - Accessories MMA pag. 108 TIG pag. 110			

Funzioni - Features	MMA DC	TIG DC
Ventilata - Fan cooled	●	
Hot start	Regolabile - Adjustable	-
Anti-sticking	●	-
Arc force	Regolabile - Adjustable	-
TIG	-	Lift

Optionals i-ARC 525 LAB

000205
Kit MMA DS20
(pag. 108)



35 mm² - 3 m

35 mm² - 2 m

DX50 mm²



010825 Torcia TIG 140A
Ø 1,6 WR2 acciaio-steel
140A 4 m
Torcia TIG / TIG torch
(pag. 110)

010571 CO₂ → Ar



010499 CO₂



NEW **010072 KIT STARTER Ø 2,4 acciaio-steel**
(pag. 111)

1x Ø 2,4 WR2



1x n.6

1x 2,4 mm

1x 2,4 mm

**TI SERVE ANCHE...
YOU ALSO NEED...**

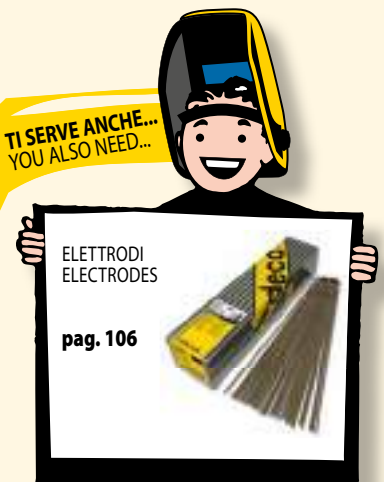

ELETTRODI
ELECTRODES

pag. 106



MMA

TIG

MIG

PAC

MMA

TIG

MIG

PAC

CAR BODY
REPAIR

Accessori
Accessories

Tech



Manutenzione
Maintenance
Carpenteria leggera
Light carpentry
Cantiere edile
Construction site

- Semplici e potenti
 - Robuste e durevoli
 - Carrozzeria resistente
 - Elettrodi rutili, basici
-
- Easy to use and powerful
 - Sturdy and durable
 - Tough housing
 - Rutile and basic electrodes

T-ARC 527 - 529

- **REGOLAZIONE DALL'ALTO ERGONOMICA**
ERGONOMIC KNOB ON THE TOP



T-ARC è uno strumento professionale che può facilmente incontrare i bisogni di artigiani, fabbri e manutentori.
Di rilievo i modelli con doppia tensione a vuoto, richiesti per particolari tipi di elettrodo

T-ARC is a professional tool that can easily meet the needs of craftsmen, blacksmiths and maintenance operators.
The models with double no-load voltage, required for particular types of electrodes, are particularly remarkable.



MADE IN SAN MARINO		T-ARC 525 LAB	T-ARC 527 LAB	T-ARC 529 LAB		T-ARC 530 LAB		T-ARC 845 LAB
		MMA AC	MMA AC	MMA AC		MMA AC		MMA AC
Selezione uscita - Output selection		-	-	50V	70V	50V	70V	-
Campo di regolazione - Welding current range		40 - 240A	50 - 240A	50 - 240A	50 - 220A	26 - 280A	22 - 250A	70 - 440A
Servizio 40°C - Duty cycle 40°C EN 60974-1		220A - 8%	220A - 10%	220A - 10%	205A - 7%	260A - 20%	230A - 20%	400A - 13%
		80A - 60%	90A - 60%	90A - 60%	70A - 60%	155A - 60%	130A - 60%	190A - 60%
Tensione a vuoto - Open circuit voltage		44 - 54V	42 - 48V	42 - 67V		38 - 77V		48 - 64V
Tensione di alimentazione - Input voltage		1 ph - 230/400V 50/60 Hz						
Potenza assorbita - Absorbed power: 60% / Max		2,5 / 7,5 kW	2,5 / 7,5 kW	2,5 - 7,5 kW		5 / 9,5 kW		6,2 / 17 kW
Fusibile - Fuse		25/20A	32/20A			32/25A		50/50A
Elettrodi : ø mm Electrodes: ø mm	Rutile	1,6 - 5,0	1,6 - 5,0	1,6 - 5,0		1,6 - 5,0		2,5 - 8,0
	Basico - Basic (AC)	-	-	2,0 - 4,0		2,0 - 4,0		2,5 - 5,0
Connessioni in uscita - Output connection		DX 25 mmq				DX 50 mmq		DX 70 mmq
Ventilata - Fan cooled		•	•	•		•		•
Regolazione continua - Stepless regulation		•	•	•		•		•
Protezione termostatica - Thermostatic Protection		•	•	•		•		•
Peso - Weight ≈		25 kg	28 kg	29 kg		61 kg		74 kg
Dimensioni - Dimensions		710 x 350 x 430 mm	420 x 380 x 750 mm			780 x 490 x 615 mm		
Versione - Version								
Solo generatore - Power source only		205300	219000	219100		205500		205600
Accessori - Accessories MMA pag. 108								

MMA

TIG

MIG

PAC

MMA

TIG

MIG









PAC

CAR BODY REPAIR

Accessori Accessories

Tech

Optionals KIT MMA (pag. 108)

000217 DS/20 T-ARC 525 - 527 - 529 LAB			
	25 mm ² - 3 m	25 mm ² - 2 m	DX25 mm ²
000205 DS/35 T-ARC 530 LAB			
	35 mm ² - 3 m	35 mm ² - 3 m	DX50 mm ²
000207 DS/50 T-ARC 845 LAB			
	50 mm ² - 3 m	50 mm ² - 3 m	DX70 mm ²



MMA TRADITIONAL



Carpenteria leggera
Light carpentry

Cantieri edile
Construction site

Carpenteria pesante
Heavy carpentry

P-ARC

- Corrente raddrizzata
- Robuste e durevoli
- Carrozzeria resistente
- Elettrodi rutili, basici
- Rectified current
- Sturdy and durable
- Tough housing
- Rutile and basic electrodes

E-ARC

- Controllata a tiristore
- Corrente raddrizzata
- Comando a distanza
- Carrozzeria resistente
- Elettrodi rutile, basico cellulosici, alluminio e TIG LIFT
- TIG LIFT con elettrovalvola
- Thyristor controlled
- Rectified current
- Remote control
- Tough housing
- Rutile, Basic, cellulosic, aluminum electrodes and TIG LIFT

- ELETTRDI CELLULOSICI / ALLUMINIO
- CELLULOSIC / ALUMINUM ELECTRODES



P-ARC è la tradizionale macchina DECA per il cantiere pesante, per saldatura di lamiere di grande spessore con elettrodi di basici e turni di lavoro gravosi. La struttura è particolarmente robusta, adatta per ambienti operativi tipici della carpenteria industriale.

P-ARC is the traditional DECA heavy construction machine, for welding thick sheets with basic electrodes and heavy work shifts. The structure is particularly robust, suitable for operating environments typical of industrial carpentry.



E-ARC è la saldatrice tradizionale ad elettrodo più evoluta della gamma DECA. Idonea per elettrodi di ogni tipo, molto robusta e potente, ha il grande vantaggio di permettere la regolazione a distanza della corrente, una caratteristica richiesta spesso per la saldatura di oggetti di grande dimensione.

E-ARC is the most advanced traditional electrode welding machine in the DECA range. Suitable for electrodes of all kinds, very robust and powerful, it has the great advantage of allowing remote adjustment of the current, a feature often required for welding large objects.



*E-ARC Accessori in dotazione - Supplied accessories

Comando a distanza manuale 4 m
Manual remote control 4 m



MADE IN SAN MARINO		P-ARC 525 LAB		P-ARC 526 LAB	P-ARC 735 LAB	P-ARC 840 LAB	P-ARC 846 LAB	E-ARC 840 LAB	E-ARC 860 LAB	
		MMA AC	MMA DC	MMA DC	MMA DC	MMA DC	MMA DC	MMA DC	MMA DC	
Campo di regolazione Welding current range		40 - 240A	25 - 155A	45 - 260A	55 - 350A	70 - 400A	65 - 460A	20 - 380A	15 - 500A	
Servizio 40°C Duty cycle 40°C EN 60974-1		220A - 8%	145A - 15%	180A - 35%	300A - 35%	380A - 35%	450A - 35%	350A - 35%	450A - 35%	
		80A - 60%	70A - 60%	120A - 60%	200A - 60%	250A - 60%	340A - 60%	270A - 60%	340A - 60%	
Tensione a vuoto Open circuit voltage		44 - 54V	65 - 77V	63 - 74V	71 - 78V	70 - 76V	66 - 80V	85V	85V	
Tensione di alimentazione Input voltage		1 ph - 230/400V 50/60 Hz		3 ph - 230/400V 50/60 Hz						
Potenza assorbita - Absorbed power: 60% / Max		2,5 / 7,5 kW		3,5 / 9 kW	6,5 / 14 kW	9 / 17 kW	13,5 / 20 kW	9,8 / 15,7 kW	13,5 / 23,5 kW	
Fusibile - Fuse		25/20A		32/20A	50/32A	63/40A	80/50A	40/25A	50/32A	
Elettrodi: ø mm Electrodes: ø mm		Rutile	1,6 - 5,0		1,6 - 5,0	2,0 - 7,0	2,0 - 8,0	2,0 - 8,0	2,0 - 8,0	
		Basico Basic	2,0 - 3,2		2,0 - 5,0	2,0 - 5,0	2,0 - 5,0	2,0 - 5,0	2,0 - 5,0	
		Cellulosic Cellulosic	-	-	-	-	-	-	2,5 - 6,0	2,5 - 6,0
		Alluminio Aluminum	-	-	-	-	-	-	2,5 - 4,0	2,5 - 6,0
		TIG	-	-	-	-	-	-	1,6 - 4,0	1,6 - 4,0
Connessioni in uscita Output connection		DX 25 mmq		DX 50 mmq		DX 70 mmq		DX 70 mmq	DX 70 mmq	
Ventilata - Fan cooled		●		●	●	●	●	●	●	
Regolazione continua Stepless regulation		●		●	●	●	●	●	●	
Protezione termostatica Thermostatic Protection		●		-	-	-	-	●	●	
Peso - Weight ≈		32 kg		59 kg	101 kg	112 kg	130 kg	112 kg	130 kg	
Dimensioni - Dimensions		710 x 350 x 430 mm		780 x 490 x 615 mm	890 x 570 x 720 mm		800 x 585 x 760 mm			
Versione - Version										
Solo generatore Power source only		205400		227400	227500	227600	227700	220000	220100	
Accessori - Accessories MMA pag. 102										

Funzioni - Features								
Hot Start	-	-	-	-	-	-	Regolabile - Adjustable	Regolabile - Adjustable
Anti-sticking	-	-	-	-	-	-	●	●
Arc force	-	-	-	-	-	-	Regolabile - Adjustable	Regolabile - Adjustable
Elettrovalvola gas Gas valve	-	-	-	-	-	-	●	●
TIG	-	-	-	-	-	-	Lift	Lift

Optionals E-ARC 840 - 860 LAB



010230 Torcia TIG 180A
Ø 1,6 WR2 acciaio-steel
180A 4 m
Torcia TIG / TIG torch
(pag. 111)

010072 KIT STARTER Ø 2,4 acciaio-steel
(pag. 111)



Optionals KIT MMA (pag. 108)

000217 DS/20 P-ARC 525 LAB			
	25 mm ² - 3 m	25 mm ² - 2 m	DX25 mm ²
000205 DS/35 P-ARC 526 - 735 LAB			
	35 mm ² - 3 m	35 mm ² - 3 m	DX50 mm ²
000207 DS/50 P-ARC 840 - 846 LAB E-ARC 840 LAB			
	50 mm ² - 3 m	50 mm ² - 3 m	DX70 mm ²
000209 DS/60 E-ARC 860 LAB			
	70 mm ² - 3 m	70 mm ² - 3 m	DX70 mm ²

**TI SERVE ANCHE...
YOU ALSO NEED...**

**RIDUTTORE PRESSIONE
PRESSURE REDUCER**

pag. 118

NEW

MMA

TIG

MIG

PAC

MMA

TIG

MIG

PAC

CAR BODY REPAIR

Accessori Accessories

Tech

TIG Tungsten Inert Gas



Saldatura TIG

parametri regolabili

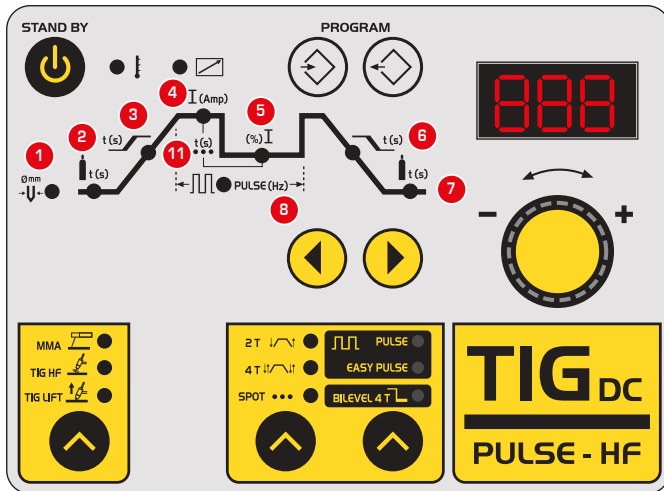

MASTROTIG DC LAB

- 1 Φ mm: Selezione del diametro dell'elettrodo di tungsteno. In base al diametro selezionato, la macchina determina l'intervallo di corrente di saldatura che puoi utilizzare senza danneggiare l'elettrodo.
- 2 PREGAS : Regolazione del tempo di pre-gas.
- 3 SLOPE-UP: Regolazione del tempo con cui la corrente di saldatura si porta dal valore iniziale (innescio dell'arco) al valore principale "I (Amp)".
- 4 I (Amp): Regolazione della corrente principale di saldatura.
- 5 (% I): Nella modalità "PULSE" e "BILEVEL 4T" regola la corrente di saldatura di base, espressa come percentuale della corrente principale di saldatura.
- 6 SLOPE-DOWN: Tempo con cui, dopo il rilascio del pulsante torcia, la corrente di saldatura si porta dal valore principale al valore finale (termine della saldatura).
- 7 POSTGAS: Regolazione del tempo di post-gas.
- 8 PULSE (Hz): Nella modalità "TIG PULSE" varia la frequenza di pulsazione.
- 9 BALANCE (%): (TIG AC): Nella modalità di saldatura in corrente alternata, modifica il rapporto fra la durata dell'asemionda positiva e della semionda negativa. Bassi valori di "balance" consentono maggiore penetrazione dell'arco e poca usura dell'elettrodo. Alti valori di "balance" consentono maggiore pulizia del pezzo ma elevata usura dell'elettrodo.
- 10 FREQUENCY (Hz) (TIG AC): Nella modalità di saldatura in corrente alternata, varia la frequenza della corrente di saldatura. Bassi valori consentono un arco più distribuito. Alti valori consentono un arco più concentrato.
- 11 T (SPOT): Nella modalità "SPOT" varia la durata del punto di saldatura.
- 4 + 5 TEMPO DI SALDATURA
Regolazione della durata del tempo di saldatura a punti

TIG Welding

adjustable parameters

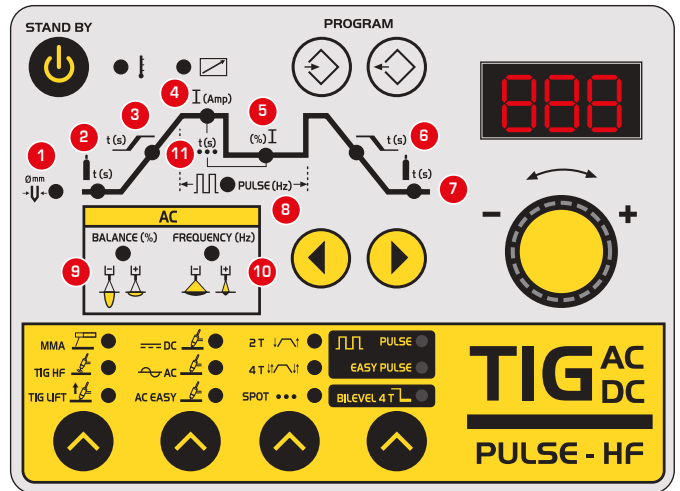

MASTROTIG AC/DC LAB

- 1 Φ mm: Select the diameter of the tungsten electrode. Based on the diameter selected, the machine determines the welding current interval that can be used without damaging the electrode.
- 2 PREGAS: Pre-gas time adjustment.
- 3 SLOPE-UP: Adjustment of time at which the welding current is brought from the initial value (arc start) to the main value "I (Amp)".
- 4 I (Amp): Main welding current adjustment.
- 5 (% I): In the "PULSE" and "BILEVEL 4T" modes, it adjusts the base welding current, expressed as a percentage of the main welding current.
- 6 SLOPE-DOWN: Time at which, once the torch button is released, the welding current is brought from the main value to the final value (end of welding).
- 7 POSTGAS: Post-gas time adjustment.
- 8 PULSE (Hz): In the "TIG PULSE" mode, it varies the pulse frequency.
- 9 BALANCE (%): In the "TIG AC" welding mode at alternating current, it modifies the ratio between the duration of the positive and the negative half waves. Low "balance" values allow for enhanced arc penetration and little electrode wear and tear. High "balance" values allow for better cleaning of the workpiece but increased electrode wear and tear.
- 10 FREQUENCY (Hz): In the "TIG AC" welding mode at alternating current, it varies the welding current frequency. Low values allow for a better distributed arc. High values allow for a more concentrated arc.
- 11 T (SPOT): In the "SPOT" mode it varies the duration of the welding point.
- 4 + 5 SPOT WELDING TIME
Spot welding time adjustment

MMA

TIG

MIG

PAC

MMA

TIG

MIG

PAC

CAR BODY REPAIR

Accessori Accessories

Tech

**TIG INVERTER
MODEL 2021**

**Saldatura pulsata
Pulsed welding**



Manutenzione
Maintenance
Carpenteria leggera
Light carpentry
Autoriparazioni
Automotive
Saldatura di precisione
Precision welding

- Top di gamma per innesco, potenza e stabilità d'arco
- Compatte e maneggevoli
- Carrozzeria in alluminio
- Regolazione completa dei parametri di saldatura
- TIG con innesco HF o LIFT
- Elettrodi rutili, basici
- Top of range for arc striking power and arc stability
- Compact and Handy
- Aluminum housing
- Complete adjustment of the welding parameters
- TIG with HF or LIFT arc striking
- Rutile, Basic electrodes

EASY PULSE

Regolazione automatica della corrente base e della frequenza di pulsazione in funzione della corrente di picco impostata. Semplifica notevolmente il procedimento di saldatura TIG con corrente alternata.

Automatic regulation of the base current and the pulsation frequency according to the set peak current. It considerably simplifies the TIG welding process with alternating current.

AC EASY

Regolazione automatica della frequenza e del bilanciamento dell'onda alternata in funzione della corrente impostata per la saldatura dell'alluminio. Semplifica notevolmente il procedimento di saldatura TIG con corrente alternata.

Automatic regulation of the frequency and the balance of the alternating wave according to the current set for welding aluminum. It considerably simplifies the TIG welding process with alternating current.

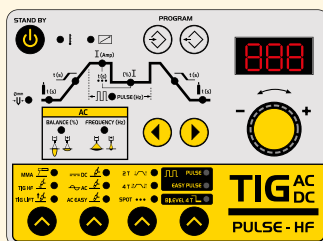
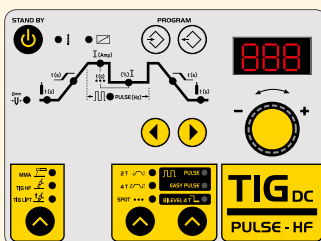

(pag. 45)



MASTROTIG è la gamma professionale completa che DECA ha studiato con attenzione per tutte le esigenze di saldatura TIG per tutti i metalli. Si può scegliere il modello più idoneo in base al tipo di procedimento desiderato e all'alimentazione elettrica disponibile.

MASTROTIG is the complete professional range carefully designed by DECA for all TIG welding needs and all metals. The most suitable model can be chosen according to the type of process desired and the available power supply.

*MASTROTIG 218 DC LAB Accessori in dotazione - Supplied accessories

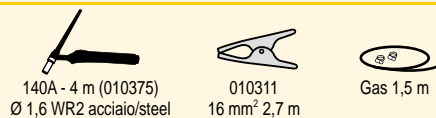

140A - 4 m (010375)
Ø 1,6 WR2 acciaio/steel

010311
16 mm² 2,7 m

Gas 1,5 m

*MASTROTIG 216 AC/DC LAB Accessori in dotazione - Supplied accessories

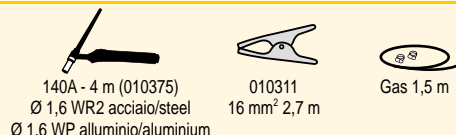

140A - 4 m (010375)
Ø 1,6 WR2 acciaio/steel
Ø 1,6 WP alluminio/aluminium

010311
16 mm² 2,7 m

Gas 1,5 m



MADE IN SAN MARINO		MASTROTIG 218 DC LAB		MASTROTIG 216 AC/DC LAB		
		MMA DC	TIG DC	MMA DC	TIG AC	TIG DC
Campo di regolazione - Welding current range		20 - 180A	5 - 200A	20 - 130A	5 - 160A	5 - 160A
Servizio 40°C - Duty cycle 40°C EN 60974-1		180A - 30%	200A - 30%	130A - 25%	160A - 20%	160A - 20%
		130A - 60%	140A - 60%	80A - 60%	85A - 60%	85A - 60%
Tensione a vuoto - Open circuit voltage		90V		105V		
Tensione di alimentazione - Input voltage		1 ph - 230V 50/60 Hz		1 ph - 230V 50/60 Hz		
Potenza assorbita - Absorbed power: 60% / Max		3,3 / 5,7 kW		2 / 4 kW		
Fusibile - Fuse		25A		16A		
Elettrodi : ø mm Electrodes: ø mm	Rutile - Rutile Basico - Basic	1,6 - 5,0	—	1,6 - 3,2	—	
	TIG	—	1,0 - 4,0	—	1,0 - 3,2	
Connessioni in uscita - Output connection		DX 25 mmq		DX 25 mmq		
Protezione termostatica - Thermostatic Protection		●		●		
Peso - Weight ≈		9 kg		11 kg		
Dimensioni - Dimensions		418 x 196 x 343 mm		415 x 193 x 417 mm		
Versione - Version						
*Generatore + accessori - *Power source + accessories		284100		284200		
Accessori - Accessories MMA pag. 108 TIG pag. 110						

Funzioni - Features	MMA DC	TIG DC	MMA DC	TIG AC	TIG DC
TIG HF - Lift	—	●	—	●	●
TIG Pulse	—	●	—	●	●
Easy Pulse	—	●	—	●	●
Frequenza di pulsazione - Pulse frequency	—	0,2 - 250 Hz	—	0,2 - 2 Hz	0,2 - 250 Hz
Frequenza AC - AC Frequency	—	—	—	10 - 200 Hz	—
AC Easy	—	—	—	●	—
Balance AC	—	—	—	●	—
Bilevel	—	●	—	●	●
Pregas - Postgas	—	Regolabile - Adjustable	—	Regolabile - Adjustable	—
Slope Up - Slope Down	—	Regolabile - Adjustable	—	Regolabile - Adjustable	—
2T - 4T	—	●	—	●	●
Spot	—	Regolabile - Adjustable	—	Regolabile - Adjustable	—
Memoria Programmi - Program saving	9		9		
Hot start	Regolabile - Adjustable	—	Regolabile - Adjustable	—	—
Anti-sticking	●	—	●	—	—
Arc force	Regolabile - Adjustable	—	Regolabile - Adjustable	—	—

Optionals MASTROTIG 218 DC LAB - 216 AC/DC LAB

NEW 010072 KIT STARTER Ø 2,4 acciaio-steel (pag. 111)
1x Ø 2,4 WR2
1x n.6 1x 2,4 mm 1x 2,4 mm

010395 9 m

010390 9 m

NEW 010069 KIT MMA (pag. 112)
200A
+
16 mm² - 2,7 m
+
DX25 mm²

010890 Carrello CR26 CR26 Trolley

TI SERVE ANCHE... YOU ALSO NEED...

ELETTRODI TIG TIG ELECTRODES
pag. 112

MMA
TIG
MIG
PAC
MMA
TIG
MIG
PAC
CAR BODY REPAIR
Accessori Accessories
Tech



MASTROTIG 327

LAB

AC
~

DC
-+

TIG INVERTER

MODEL 2021



Saldatura pulsata
Pulsed welding

Manutenzione
Maintenance

Carpenteria leggera
Light carpentry

Autoriparazioni
Automotive

Saldatura di precisione
Precision welding

- Top di gamma per innescò, potenza e stabilità d'arco
 - Alimentazione trifase
 - Regolazione completa dei parametri di saldatura
 - TIG con innescò HF o LIFT
 - Elettrodi rutili, basici
 - Predisposizione per raffreddamento ad acqua
- Top of range for arc striking power and arc stability
 - Three-phase power supply
 - Complete adjustment of the welding parameters
 - TIG with HF or LIFT arc striking
 - Rutile, Basic electrodes
 - Ready for water cooling unit

• EASY PULSE

Regolazione automatica della corrente base e della frequenza di pulsazione in funzione della corrente di picco impostata. Semplifica notevolmente il procedimento di saldatura TIG con corrente alternata.

Automatic regulation of the base current and the pulsation frequency according to the set peak current. It considerably simplifies the TIG welding process with alternating current.

• AC EASY

Regolazione automatica della frequenza e del bilanciamento dell'onda alternata in funzione della corrente impostata per la saldatura dell'alluminio. Semplifica notevolmente il procedimento di saldatura TIG con corrente alternata.

Automatic regulation of the frequency and the balance of the alternating wave according to the current set for welding aluminum. It considerably simplifies the TIG welding process with alternating current.

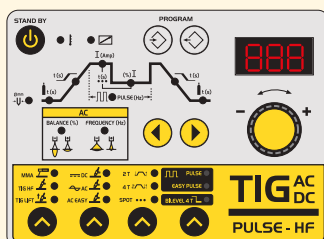

(pag. 45)

*Accessori in dotazione - Supplied accessories



010315
35 mm² - 3 m



Gas 1,5 m



MADE IN SAN MARINO		MASTROTIG 327 AC/DC LAB		
		MMA DC	TIG AC	TIG DC
Campo di regolazione - Welding current range		20 - 270A	5 - 270A	5 - 270A
Servizio 40°C - Duty cycle 40°C EN 60974-1		270A - 40%	270A - 40%	270A - 40%
		215A - 60%	215A - 60%	215A - 60%
Tensione a vuoto - Open circuit voltage		55V		
Tensione di alimentazione - Input voltage		3 ph - 400V 50/60 Hz		
Potenza assorbita- Absorbed power: 60% / Max		7 / 10 kW		
Fusibile - Fuse		16A		
Elettrodi : Ø mm Electrodes: Ø mm	Rutile - Rutile Basico - Basic	1,6 - 6,0	-	
	TIG	-	1,0 - 4,0	
Connessioni in uscita - Output connection		DX 50 mmq		
Protezione termostatica - Thermostatic Protection		●		
Peso - Weight ≈		33 kg		
Dimensioni - Dimensions		550 x 250 x 490 mm		
Versione - Version				
Solo generatore - Power source only		285000		
Accessori - Accessories MMA pag. 108 TIG pag. 110				

Funzioni - Features	MMA DC	TIG AC	TIG DC
TIG HF - Lift	-	●	
TIG Pulse	-	●	
Easy Pulse	-	●	
Frequenza di pulsazione - Pulse frequency	-	0,2 - 2 Hz	0,2 - 250 Hz
Frequenza AC - AC Frequency	-	10 - 200 Hz	-
AC Easy	-	●	-
Balance AC	-	Regolabile - Adjustable	-
Bilevel	-	●	
Pregas - Postgas	-	Regolabile - Adjustable	
Slope Up - Slope Down	-	Regolabile - Adjustable	
2T - 4T	-	●	
Spot	-	Regolabile - Adjustable	
Memoria Programmi - Program saving	9		
Hot start	Regolabile - Adjustable	-	
Anti-sticking	●	-	
Arc force	Regolabile - Adjustable	-	

Optionals MASTROTIG 327 AC/DC LAB

AIR

180A
Ø 1,6 WR2 acciaio/steel
010811 4 m
010812 8 m
(pag. 111)

NEW **010083 KIT STARTER**
1x Ø 1,6 - 2,4 - 3,2 WP alluminio - aluminium
1x Ø 2,4 - 3,2 WC20 acciaio - steel
(pag. 111)

1x n.8 1x 2,4-3,2 mm 1x 2,4-3,2 mm

NEW **010070 KIT MMA**
(pag. 112)

300A
+
35 mm² - 3 m
+
DX50 mm²

010390
9 m

H2O

320A H2O
Ø 1,6 WR2 acciaio/steel
010813 4 m
010815 8 m
(pag. 111)

010624 WU20
Impianto raffreddamento
Water cooling unit

010395
9 m

010877
Carrello CR27
CR27 Trolley

m³ 10

MMA

TIG

MIG

PAC

MMA

TIG

MIG

PAC

CAR BODY REPAIR

Accessori Accessories

Tech

MIG

Saldatura a filo continuo

Continuous wire welding



EASY JOB 525 LAB

EASY MIG Full Setting è un sistema di controllo basato su tre manopole che consente la regolazione immediata della saldatrice nei processi MIG/MAG, NO-GAS, elettrodo e TIG DC Lift.

Con il potenziometro 1 scelgo il procedimento, con il 2 regolo la corrente, con il 3 aggiusto la tensione d'arco di saldatura a filo.

EASY MIG Full Setting is a control system based on three knobs that allows immediate adjustment of the welding machine in the different processes: MIG / MAG, NO-GAS, electrode and TIG DC Lift.

With potentiometer 1 I choose the procedure, with 2 I adjust the current, with 3 I adjust the arc voltage of wire welding.

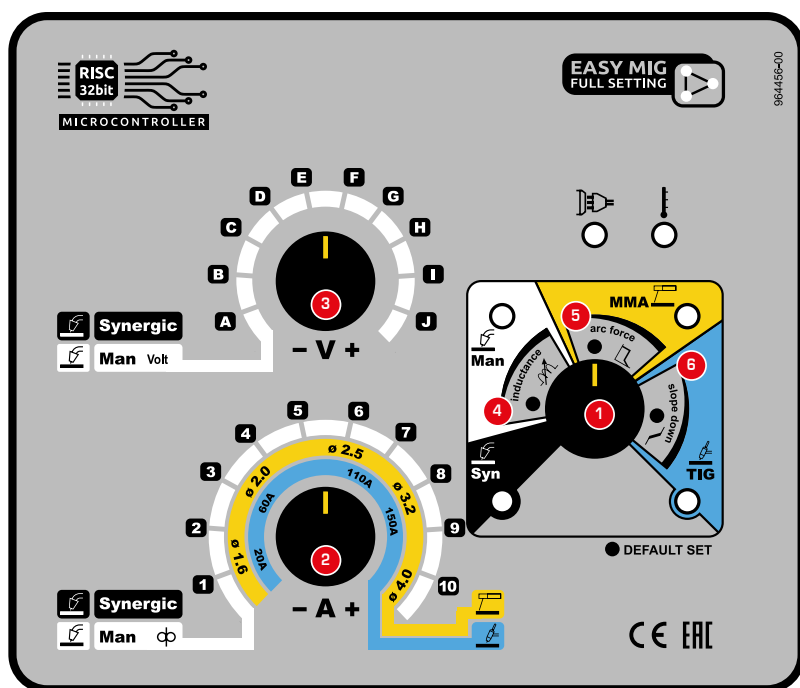

- 1 **Selezione processo di saldatura**
 - **Syn**: saldatura a filo in modalità Sinergica
 - **Man**: saldatura a filo in modalità Manuale
 - **MMA**: saldatura ad elettrodo
 - **TIG**: saldatura TIG DC Lift
- 2 **Regolazione corrente di saldatura (Ampere)**
 - **Syn**: posizionare il potenziometro sul numero della corona in base al programma sinergico scelto
 - **Man**: regolazione velocità filo
 - **MMA**: regolazione corrente (corona gialla)
 - **TIG**: regolazione corrente (corona blu)
- 3 **Regolazione tensione di saldatura (Volt)**
 - **Syn**: posizionare il potenziometro sulla lettera della corona in base al programma sinergico scelto
 - **Man**: regolazione tensione d'arco
- 4 **Regolazione elettronica induttanza in saldatura a filo manuale**
- 5 **Regolazione ARC FORCE in saldatura ad elettrodo**
- 6 **Regolazione rampa di discesa (Slope Down) in saldatura TIG**

- 1 **Welding process selection**
 - **Syn**: wire welding in Synergic mode
 - **Man**: wire welding in Manual mode
 - **MMA**: electrode welding
 - **TIG**: TIG DC Lift welding
- 2 **Welding current regulation (Amp)**
 - **Syn**: set the potentiometer on the number corresponding to the synergic program
 - **Man**: wire speed adjustment
 - **MMA**: current adjustment (yellow scale)
 - **TIG**: current adjustment (blue scale)
- 3 **Welding voltage adjustment (Volt)**
 - **Syn**: place the potentiometer on the letter corresponding to the synergic program
 - **Man**: arc voltage regulation
- 4 **Electronic inductance adjustment in manual wire welding**
- 5 **ARC FORCE adjustment in electrode welding**
- 6 **Slope Down adjustment in TIG welding**



JOB Series

Il controllo delle saldatrici inverter **JOB** offre un utilizzo semplice ed intuitivo. E' sufficiente impostare il materiale e le dimensioni del filo per regolare automaticamente tutti gli altri parametri.

Tramite **SD Card** è possibile aggiornare il software aggiungendo nuovi programmi sinergici.

Saldatura MIG, TIG ed MMA rendono la macchina molto flessibile.

A seconda dei modelli è previsto l'utilizzo di una o più torce.

The **JOB** inverter welding machines control offers a simple and immediate use. It is enough to set the material and the wire size to adjust automatically all other parameters.

Thanks to the **SD Card** reader, it is possible to update the software adding new synergic welding programs.

MIG, TIG and MMA welding processes make the machine very flexible. Depending on the model, it is possible to connect one or more MIG torches.

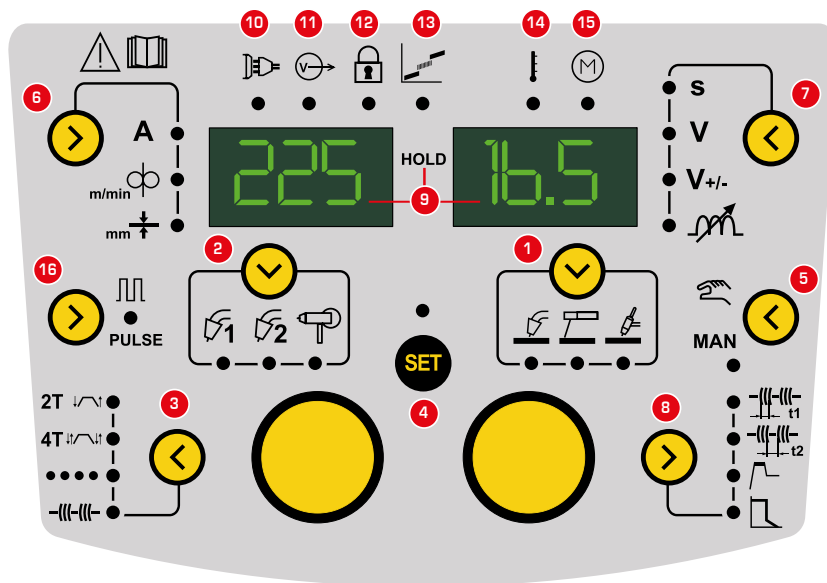

Caratteristiche

- 1 **Selezione processo di saldatura**
 - MIG - MAG / MMA / TIG
- 2 **Selezione torcia**
 - MIG1 / MIG2 / Spool Gun 1 - Spool Gun 2*
- 3 **Selezione modalità di saldatura MIG**
 - 2 tempi (2T) / 4 tempi (4T) / Spot (puntatura) / Stitch (tratteggio)
- 4 **Selezione programma sinergico MIG**
 - Materiale, diametro filo e gas di protezione
- 5 **Selezione funzionamento manuale MIG**
- 6 **Selezione parametri**
 - Sinergico: selezione spessore materiale o regolazione Amp o velocità del filo
 - Manuale: regolazione velocità filo
- 7 **Selezione parametri:**
 - Sinergico: aggiustaggio della tensione di saldatura ed induttanza
 - Manuale: regolazione della tensione di saldatura ed induttanza (Abilitazione della regolazione dei tempi di saldatura e pausa)
- 8 **Regolazione parametri**
 - Saldatura MIG: tempo di saldatura e pausa nella modalità spot e stitch;
 - Saldatura MMA: regolazione hot start, arc force
- 9 **Amperometro / Voltmetro durante la saldatura. Led hold acceso: valore medio dei parametri utilizzati al termine della saldatura.**
- 10 **Spia tensione di alimentazione**
- 11 **Spia tensione sulle prese**
- 12 **Spia di blocco tastiera attivato**
- 13 **Spia di parametri saldatura non ottimali (MIG)**
- 14 **Spia protezione termica**
- 15 **Spia sovraccarico motore trainafilo**
- 16 **Saldatura con corrente pulsata**

* Valori differenti a seconda dei modelli

Features

- 1 **Selection of welding process**
 - MIG - MAG / MMA / TIG
- 2 **Torch selection**
 - MIG1 / MIG2 / Spool Gun 1 - Spool Gun 2*
- 3 **MIG welding mode selection**
 - 2-stroke (2T) / 4-stroke (4T) / Spot (spot-welding) / Stitch
- 4 **MIG synergic program selection**
 - Material, wire diameter and gas
- 5 **MIG manual welding mode selection**
- 6 **Parameters selection**
 - Synergic: selection of material thickness or adjustment of Amp or wire speed
 - Manual: wire speed adjustment
- 7 **Parameters selection**
 - Synergic: welding voltage and inductance fine setting
 - Manual: welding voltage and inductance adjustment (Enabling the adjustment of welding and pause times)
- 8 **Parameters adjustment**
 - MIG welding: welding and pause times in Spot and Stitch modes;
 - MMA welding: hot start and arc force adjustment
- 9 **Ammeter / Voltmeter during welding. With "hold" indicator light on: average value of the parameters at the end of the welding process.**
- 10 **Power supply indicator light**
- 11 **Voltage on the sockets indicator light**
- 12 **Keypad lock indicator light**
- 13 **Non-optimal welding parameters (MIG) indicator light**
- 14 **Thermostatic protection indicator light**
- 15 **Wire feeder motor overload indicator light**
- 16 **Welding with pulsed current**

* Different values depending on the models

MIG

JOB 635 - 524 T3 LAB

Il controllo delle saldatrici inverter **JOB** offre un utilizzo semplice ed intuitivo. Il nuovo display digitale LCD a colori ha reso possibile la realizzazione di un'interfaccia che guida l'utilizzatore attraverso le regolazioni della saldatrice. E' sufficiente impostare il materiale e le dimensioni del filo per regolare automaticamente tutti gli altri parametri. Saldatura MIG, TIG ed MMA rendono la macchina molto flessibile. A seconda dei modelli è previsto l'utilizzo di una o più torce.

The **JOB** inverter welding machines control offers a simple and immediate use. The new color LCD digital display made it possible to create an interface that guides the user in the adjustments of the welding machine. It is enough to set the material and the wire size to adjust automatically all other parameters. MIG, TIG and MMA welding processes make the machine very flexible. Depending on the model, it is possible to connect one or more MIG torches.

Selezione del processo di saldatura

Selection of the welding process

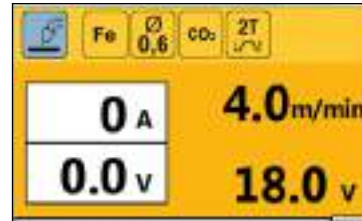

Cruscotto saldatura MIG manuale

Manual MIG welding dashboard

Regolazione della sinergia MIG

Setting MIG synergy

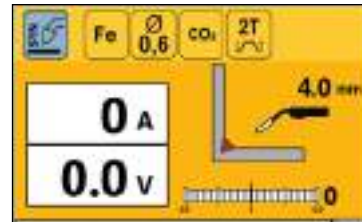

Cruscotto saldatura MIG sinergica

Synergic MIG welding dashboard



MMA

TIG

MIG

PAC

MMA

TIG

MIG

PAC

CAR BODY REPAIR

Accessori Accessories

Tech

Easy JOB 525 LAB

MIG MAG
NO GAS

MMA

TIG

MULTIPROCESS INVERTER

NEW



250 Amp

Manutenzione
Maintenance

Carpenteria leggera
Light carpentry

Autoriparazioni
Automotive

- Top di gamma per innesco, potenza e stabilità d'arco
- Impianti multiprocesso ad alta qualità di saldatura
- Induttanza, Arc Force e Slope down regolabili
- Facili da usare grazie alla regolazione sinergica dei parametri di saldatura
- Scomparto inferiore porta oggetti
- Top of range for arc striking power and arc stability
- Multiprocess welders with high quality welding
- Adjustable inductance, Arc Force, Slope down
- Easy to use thanks to the synergic adjustment of the welding parameters
- Storage compartment

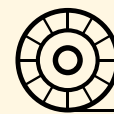

15 kg MAX



TRAINAFILO PROFESSIONALE D. 30
PROFESSIONAL WIRE FEEDER D. 30



RUOTE INDUSTRIALI
HEAVY DUTY WHEELS



PORTA TORCIA
TORCH HOLDER

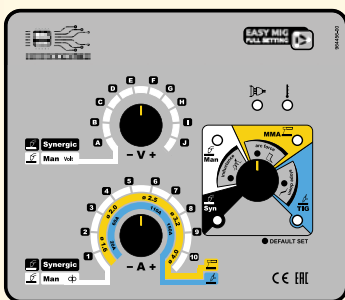

(pag. 51)

Generatori a tecnologia inverter, controllati a microprocessore per saldatura MIG/MAG con corrente liscia e pulsata (JOB P) a filo NO GAS, MMA e TIG DC.
Controllo completo di tutti i parametri di saldatura, programmi sinergici per molte delle applicazioni più comuni con diversi materiali.
JOB è la scelta da fare se la saldatura è un mestiere da fare con cura e precisione.
Alcuni modelli sono particolarmente studiati per la carrozzeria.
Inverter technology power sources controlled by microprocessor for MIG/MAG with conventional and PULSED current (JOB P), NO-GAS wire, MMA and TIG DC welding.
Complete control of all welding parameters, synergic programs for many of the most common applications with different materials. JOB is the right choice if welding is a job to do with care and precision. Some models are specifically designed for the bodywork.

*Accessori in dotazione - Supplied accessories

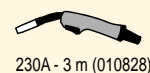

230A - 3 m (010828)



010311
25 mm² - 2,7 m



Gas 1,5 m



B
Ø 0,6 / 0,8 Fe
(011214)
Ø 1,0 / 1,2 Fe
(011215)



MADE IN SAN MARINO		Easy JOB 525 LAB		
		MIG MAG / NO GAS	MMA	TIG
Campo di regolazione - Welding current range		10 - 250A	10 - 200A	10 - 250A
Servizio 40°C - Duty cycle 40°C EN 60974-1		220A - 20%	180A - 25%	220A - 20%
		120A - 60%	120A - 60%	120A - 60%
Tensione a vuoto - Open circuit voltage		96V		
Tensione di alimentazione - Input voltage		1 ph - 230V - 50/60 Hz		
Potenza assorbita - Absorbed power: 60% / Max		3,3 / 6,3 kW		
Fusibile - Fuse		25A		
Modalità MIG - MIG Mode		MANUAL / SYNERGIC	-	-
Filo ø mm Wires ø mm	Acciaio - Steel	0,6 - 0,8 - 0,9 - 1,0 - 1,2	-	-
	Inox	0,8 - 1,0	-	-
	Al.Mg 5	0,8 - 1,0 - 1,2	-	-
	Al.Si 5	1,0 - 1,2	-	-
	Cu.Si 3	0,8 - 1,0	-	-
	Cu.Al 8	0,8 - 1,0	-	-
	Filo animato - Flux cored	0,6 - 0,8 - 0,9 - 1,0 - 1,2	-	-
Bobina ø mm - Wire spool ø mm		200 - 300		
Elettrodi : ø mm Electrodes: ø mm	Rutile / Basico Rutile / Basic	-	1,6 - 4,0	-
	TIG	-	-	1,0 - 4,0
	Trainafile - Wire feeder	2 rulli - 2 rollers		
Connessioni in uscita - Output connection		DX 50 mmq / Euro		
Protezione termostatica - Thermostatic Protection		●		
Peso - Weight ≈		30 kg		
Dimensioni - Dimensions		775 x 400 x 790 mm		
Versione - Version				
*Generatore + accessori - *Power source + accessories		242200		
Accessori - Accessories MMA pag. 108 - TIG pag. 110 - MIG pag. 113				

Funzioni - Features	MIG MAG / NO GAS	MMA	TIG
Saldatura sinergica - Synergic welding	●	-	-
Induttanza elettronica - Electronic inductor	Regolabile - Adjustable	-	-
Burn back	●	-	-
Hot Start	●	●	-
Arc Force	-	Regolabile - Adjustable	-
Anti-sticking	-	●	●
Tig Lift (Torcia con rubinetto - TIG torch with gas valve)	-	-	●
Slope Up	-	-	●
Slope Down	-	-	Regolabile - Adjustable

Optionals Easy JOB 525 LAB



010825 Torcia TIG 140A
Ø 1,6 WR2 acciaio-steel
140A 4 m
Torcia TIG / TIG torch
(pag. 110)

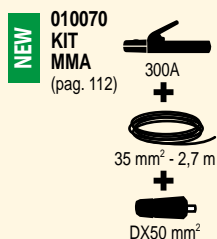

010571 CO₂ → Ar



010242 CO₂



Ø 100

010251
Aspo
Spool holder



**TI SERVE ANCHE...
YOU ALSO NEED...**



MMA

TIG

MIG

PAC

MMA

TIG

MIG

PAC

CAR BODY REPAIR

Accessori Accessories

Tech

MULTIPROCESS INVERTER

MODEL 2021



Manutenzione
Maintenance

Carpenteria leggera
Light carpentry

Autoriparazioni
Automotive

- Saldatrice sinergica alto di gamma con programmi dedicati a molti materiali
- Programmi personalizzabili e memorizzabili
- SD-Card per aggiornare ed aggiungere programmi
- Compatte e maneggevoli
- Carrozzeria leggera in alluminio
- Regolazione completa dei parametri di saldatura
- TIG con innesco LIFT
- Elettrodi rutile, basico

- High-end synergic welder with programs dedicated to many materials
- Customizable and storable programs
- SD-Card to update and add programs
- Compact and Handy
- Aluminum light cabinet
- Complete adjustment of the welding parameters
- TIG with LIFT arc striking
- Rutile, Basic electrodes

- SPECIALE GENERATORE
- GENERATOR USE



5 kg MAX



TRAINAFILO PROFESSIONALE D. 30
PROFESSIONAL WIRE FEEDER D. 30

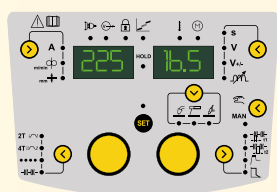

(pag. 52)

*Accessori in dotazione - Supplied accessories

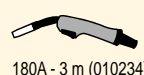

180A - 3 m (010234)



010311
16 mm² - 2,7 m



Gas 1,5 m



B
Ø 0,6 / 0,8 Fe
(011214)



MADE IN SAN MARINO		JOB 220 LAB		
		MIG MAG / NO GAS	MMA	TIG
Campo di regolazione - Welding current range		10 - 200A	10 - 160A	10 - 200A
Servizio 40°C - Duty cycle 40°C EN 60974-1		200A - 25%	160A - 30%	200A - 30%
		140A - 60%	130A - 60%	140A - 60%
Tensione a vuoto - Open circuit voltage		85V		
Tensione di alimentazione - Input voltage		1 ph - 230V - 50/60 Hz		
Potenza assorbita - Absorbed power: 60% / Max		3 / 6,0 kW		
Fusibile - Fuse		25A		
Generatore - Generator		+/- 30% (8 kW)		
Modalità MIG- MIG Mode		SYNERGIC / MANUAL	-	-
Filo ø mm Wires ø mm	Acciaio - Steel Sg2 Sg3	0,6 - 0,8 - 1,0	-	-
	Inox AISI ER308 / ER316 / ER309	0,8 - 1,0	-	-
	Al.Mg 5	0,8 - 1,0 - 1,2	-	-
	Al.Si 5	1,0 - 1,2	-	-
	Cu.Si 3	0,8 - 1,0 - 1,2	-	-
	Cu.Al 8	0,8 - 1,0 - 1,2	-	-
	Filo animato - Flux cored	0,6 - 0,9 - 1,2	-	-
Bobina ø mm- Wire spool ø mm		100 - 200		
Elettrodi : ø mm Electrodes: ø mm	Rutile / Basico Rutile / Basic	-	1,6 - 4,0	-
	TIG	-	-	1,0 - 4,0
Trainafilo - Wire feeder		2 rulli - 2 rollers		
Connessioni in uscita - Output connection		DX 25 mmq / Euro		
Amperometro - Ammeter / Voltmetro - Voltmeter		●		
Lettore SD Card - SD Card reader		●		
Protezione termostatica - Thermostatic Protection		●		
Peso - Weight ≈		12,5 kg		
Dimensioni - Dimensions		505 x 230 x 410 mm		
Versione - Version				
*Generatore + accessori - *Power source + accessories		248900		
Accessori - Accessories MMA pag. 108 - TIG pag. 110 - MIG pag. 113				

Funzioni - Features	MIG MAG / NO GAS	MMA	TIG
Saldatura sinergica - Synergic welding	●	-	-
Induttanza elettronica - Electronic inductor	Regolabile - Adjustable	-	-
Caricamento filo - Wire loading	●	-	-
Test gas - Purge	●	-	-
Pregas - Postgas	●	-	-
2T - 4T / Spot / Stich	●	-	-
Burn back	Regolabile - Adjustable	-	-
Hot Start	Regolabile - Adjustable	Regolabile - Adjustable	-
Velocità avvicinamento filo - Wire approach speed	Regolabile - Adjustable	-	-
Arc Force	-	Regolabile - Adjustable	-
Anti-sticking	-	●	●
Tig Lift (Torcia con rubinetto - TIG torch with gas valve)	-	-	●
Memoria Programmi - Program saving	16	-	-

Optionals JOB 220 LAB

NEW 010068 KIT TIG TG17
Ø 1,6 WR2 acciaio-steel
(pag. 110)

140A - 4 m

NEW 010069
KIT
MMA
(pag. 112)

200A
+
16 mm² - 2,7 m
+
DX25 mm²

010571 CO₂ → Ar

010242 CO₂

010823
Carrello CRM1
CRM1 Trolley



MMA

TIG

MIG

PAC

MMA

TIG

MIG

PAC

CAR BODY
REPAIR

Accessori
Accessories

Tech

MULTIPROCESS INVERTER

MODEL 2021

Saldatura doppia pulsata
Double pulsed welding



Manutenzione
Maintenance

Carpenteria leggera
Light carpentry

Autoriparazioni
Automotive

- Saldatrice sinergica alto di gamma con programmi dedicati a molti materiali
- Programmi personalizzabili e memorizzabili
- SD-Card per aggiornare ed aggiungere programmi
- Regolazione completa dei parametri di saldatura
- Doppia versione: corrente liscia oppure con doppia pulsazione, per lavori perfetti su materiali particolari
- Comparto inferiore porta oggetti
- High-end synergic welder with programs dedicated to many materials
- Customizable and storable programs
- SD-Card to update and add programs
- Complete adjustment of the welding parameters
- Two version: conventional current or with double current pulsation for perfect works on particular metal
- Storage compartment

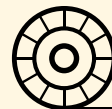
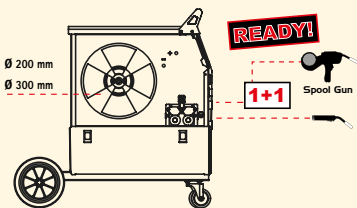

15 kg MAX



TRAINAFILO A 4 RULLI D. 37
WIRE FEEDER WITH 4 ROLLERS D. 37

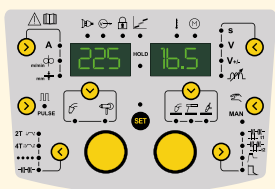
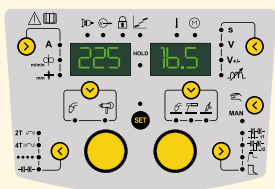

(pag. 52)



RUOTE INDUSTRIALI
HEAVY DUTY WHEELS



PORTA TORCIA
TORCH HOLDER

*Accessori in dotazione - Supplied accessories



180A - 3 m (010234)



010311
16 mm² - 2,7 m



Gas 1,5 m



Ø 0,6 / 0,8 Fe x 2
(011220)



MADE IN SAN MARINO		JOB 522 LAB			JOB 522P LAB		
		MIG	MMA	TIG	MIG	MMA	TIG
Campo di regolazione - Welding current range		10 - 200A	10 - 160A	10 - 200A	10 - 200A	10 - 160A	10 - 200A
Servizio 40°C - Duty cycle 40°C EN 60974-1		200A - 25%	160A - 30%	200A - 30%	200A - 25%	160A - 30%	200A - 30%
		140A - 60%	130A - 60%	140A - 60%	140A - 60%	130A - 60%	140A - 60%
Tensione a vuoto - Open circuit voltage		85V			85V		
Tensione di alimentazione - Input voltage		1 ph - 230V - 50/60 Hz			1 ph - 230V - 50/60 Hz		
Potenza assorbita - Absorbed power: 60% / Max		3 / 6 kW			3 / 6 kW		
Fusibile - Fuse		25A			25A		
Modalità MIG - MIG Mode		MAN / SYN	-	-	MAN / SYN	-	-
Filo ø mm Wires ø mm	Acciaio - Steel Sg2 Sg3	0,6 - 0,8 - 1,0	-	-	0,6 - 0,8 - 1,0	-	-
	Inox AISI ER308 / ER316 / ER309	0,8 - 1,0	-	-	0,8 - 1,0	-	-
	Al.Mg 5	0,8 - 1,0 - 1,2	-	-	0,8 - 1,0 - 1,2	-	-
	Al.Si 5	1,0 - 1,2	-	-	1,0 - 1,2	-	-
	Cu.Si 3	0,8 - 1,0 - 1,2	-	-	0,8 - 1,0 - 1,2	-	-
	Cu.Al 8	0,8 - 1,0 - 1,2	-	-	0,8 - 1,0 - 1,2	-	-
	Filo animato - Flux cored	0,6 - 0,9 - 1,2	-	-	0,6 - 0,9 - 1,2	-	-
Bobina Ø mm - Wire spool Ø mm		200 - 300					
Elettrodi : ø mm Electrodes: ø mm	Rutile / Basico Rutile / Basic	-	1,6 - 4,0	-	-	1,6 - 4,0	-
	TIG	-	-	1,0 - 4,0	-	-	1,0 - 4,0
Trainafile - Wire feeder		4 rulli - 4 rollers			4 rulli - 4 rollers		
Connessioni in uscita - Output connection		DX 25 mmq / Euro					
Amperometro - Ammeter / Voltmetro - Voltmeter		●					
Lettore SD Card - SD Card reader		●					
Protezione termostatica - Thermostatic Protection		●					
Peso - Weight ≈		30,0 kg			30,0 kg		
Dimensioni - Dimensions		790 x 400 x 790 mm			790 x 400 x 790 mm		
Versione - Version							
*Generatore + accessori - *Power source + accessories		250300			250700		
Accessori - Accessories MMA pag. 108 - TIG pag. 110 - MIG pag. 113							

Funzioni - Features	MIG MAG / NO GAS	MMA	TIG
Saldatura sinergica - Synergic welding	●	-	-
Saldatura pulsata - Pulsed welding	JOB 522P	-	-
Saldatura doppio pulsata - Double pulsed welding	JOB 522P	-	-
Induttanza elettronica - Electronic inductor	Regolabile - Adjustable	-	-
Caricamento filo - Wire loading	●	-	-
Test gas - Purge	●	-	-
Pregas - Postgas	●	-	-
2T - 4T / Spot / Stich	●	-	-
Burn back	Regolabile - Adjustable	-	-
Hot Start	Regolabile - Adjustable	Regolabile - Adjustable	-
Velocità avvicinamento filo - Wire approach speed	Regolabile - Adjustable	-	-
Arc Force	-	Regolabile - Adjustable	-
Anti-sticking	-	●	●
Tig Lift (Torcia con rubinetto - TIG torch with gas valve)	-	-	●
Spool Gun	●	-	-
Torcia con potenziometro - Potentiometer torch	Autosetting	-	-
Memoria Programmi - Program saving	16	-	-

Optionals JOB 522 - 522P LAB

NEW 010068 KIT TIG TG17
Ø 1,6 WR2 acciaio-steel
(pag. 110)

140A - 4 m

NEW 010069 KIT MMA
(pag. 112)

200A
16 mm² - 2,7 m
DX25 mm²

010571 CO₂ → Ar
010512 CO₂

010372 POT 3 180A 3 m
Torcia con potenziometro
Potentiometer torch
(pag. 114)

010374 Spool Gun 4
180A 6 m Euro
(pag. 115)

JOB 635 LAB 3Ph

MIG MAG

MMA

TIG

MULTIPROCESS INVERTER

NEW 03/2021



Manutenzione
Maintenance

Carpenteria leggera
Light carpentry

Carpenteria pesante
Heavy carpentry

- Saldatrice sinergica alto di gamma con programmi dedicati a molti materiali
- Display grafico a colori con comandi semplici ed intuitivi
- Programmi personalizzabili e memorizzabili
- SD-Card per aggiornare ed aggiungere programmi
- Regolazione completa dei parametri di saldatura

- High-end synergic welder with programs dedicated to many materials
- Color graphic display with simple and intuitive user interface
- Customizable and storable programs
- SD-Card to update and add programs
- Complete adjustment of the welding parameters

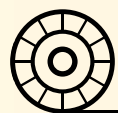

15 kg^{MAX}



TRAINAFILO A 4 RULLI D. 37
WIRE FEEDER WITH 4 ROLLERS D. 37

NEW GENERATION
100% MICROPROCESSOR
CONTROLLED



(pag. 53)



PORTA TORCIA
TORCH HOLDER

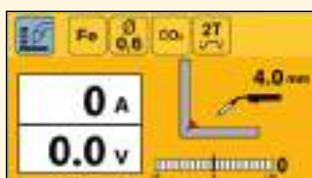

50 l.
BOMBOLA GAS
GAS BOTTLE

RUOTE INDUSTRIALI
HEAVY DUTY WHEELS

*Accessori in dotazione - Supplied accessories

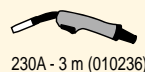

230A - 3 m (010236)



010315
35 mm² - 3 m



Gas 1,5 m



Ø 0,6 / 0,8 Fe x 2
(011220)
Ø 1,0 / 1,2 Fe x 2
(011221)



MADE IN SAN MARINO		JOB 635 LAB		
		MIG MAG	MMA	TIG
Campo di regolazione - Welding current range		10 - 330A	10 - 250A	10 - 330A
Servizio 40°C - Duty cycle 40°C EN 60974-1				
400V		300A - 35%	250A - 35%	300A - 35%
		250A - 60%	220A - 60%	250A - 60%
230V		230A - 30%	200A - 30%	230A - 30%
		200A - 60%	170A - 60%	200A - 60%
Tensione a vuoto - Open circuit voltage		58 - 61V		
Tensione di alimentazione - Input voltage		3 ph - 230/400V - 50/60 Hz (autosetting)		
Potenza assorbita - Absorbed power: 60% / Max		7 / 10 kW		
Fusibile - Fuse		16A		
Modalità MIG- MIG Mode		MAN / SYN	-	-
Filo Ø mm Wires Ø mm	Acciaio - Steel Sg2 Sg3	0,6 - 0,8 - 1,0 - 1,2	-	-
	Inox AISI ER308 / ER316 / ER309	0,8 - 1,0	-	-
	Al.Mg 5	0,8 - 1,0 - 1,2	-	-
	Al.Si 5	1,0 - 1,2	-	-
	Cu.Si 3	0,8 - 1,0 - 1,2	-	-
	Cu.Al 8	0,8 - 1,0 - 1,2	-	-
	Filo animato rutile - Flux cored FCAW	1,2	-	-
	Riporti - Hard facing	1,2	-	-
Bobina Ø mm - Wire spool Ø mm		200 - 300		
Elettrodi : Ø mm Electrodes: Ø mm	Rutile / Basico Rutile / Basic	-	1,6 - 5,0	-
	TIG	-	-	1,0 - 4,0
Trainafile - Wire feeder		4 rulli - 4 rollers		
Connessioni in uscita - Output connection		DX 50 mmq / Euro		
Amperometro - Ammeter / Voltmetro - Voltmeter		●		
Lettore SD Card - SD Card reader		●		
Protezione termostatica - Thermostatic Protection		●		
Peso - Weight ≈		46,0 kg		
Dimensioni - Dimensions		920 x 560 x 870 mm		
Versione - Version				
*Generatore + accessori - *Power source + accessories		263900		
Accessori - Accessories MMA pag. 108 - TIG pag. 110 - MIG pag. 113				

Funzioni - Features	MIG MAG	MMA	TIG
Saldatura sinergica - Synergic welding	●	-	-
Induttanza elettronica - Electronic inductor	Regolabile - Adjustable	-	-
Caricamento filo - Wire loading	●		
Test gas - Purge	●		
Pregas - Postgas	Regolabile - Adjustable	-	Regolabile - Adjustable
2T - 4T / Spot / Stich	●		
Burn back	Regolabile - Adjustable	-	-
Hot Start	Regolabile - Adjustable	Regolabile - Adjustable	-
Velocità avvicinamento filo - Wire approach speed	Regolabile - Adjustable	-	-
Arc Force	-	Regolabile - Adjustable	-
Anti-sticking	-	●	●
Tig Lift (Torch con rubinetto - Torch with gas valve)	-	-	●
Slope Up	-	-	●
Slope Down	-	-	Regolabile - Adjustable
Torchia con potenziometro - Potentiometer torch	●	-	-
Spool Gun	●	-	-
Torchia Push Pull - Push Pull Torch	●	-	-
Comando a distanza - Remote control	-	-	●
Pedale - Foot Control	-	-	●
Memoria Programmi - Program saving	16	-	-



15 kg MAX

Manutenzione
Maintenance

Carpenteria leggera
Light carpentry

Autoriparazioni
Automotive

- Il controllo MIG Synergic facilita il lavoro del saldatore gestendo in sinergia con le altre impostazioni della saldatrice, la velocità del filo, la rampa iniziale ed il burn back. Il saldatore deve soltanto attivare uno dei programmi preimpostati
- Robuste ed affidabili
- Carrozzeria resistente

- The Synergic MIG control facilitates the welding machine operator's work as it manages wire speed, soft start and burn back in a synergic way with the rest of the machine settings. The welding machine operator must simply activate one of the pre-set programs.

- Sturdy and durable
- Tough housing

Simple Weld Synergic Digital Control

Il controllo MIG Synergic facilita il lavoro del saldatore gestendo in sinergia con le altre impostazioni della saldatrice, la velocità del filo, la rampa iniziale ed il burn back. Il saldatore deve soltanto attivare uno dei programmi preimpostati. Il controllo MIG Synergic, è attivo con tutte le torce previste per la saldatrice.

The Synergic MIG control facilitates the welding machine operator's work as it manages wire speed, soft start and burn back in a synergic way with the rest of the machine settings. The welding machine operator must simply activate one of the pre-set programs. The Synergic MIG control is active with all the torches provided for the welding machine.

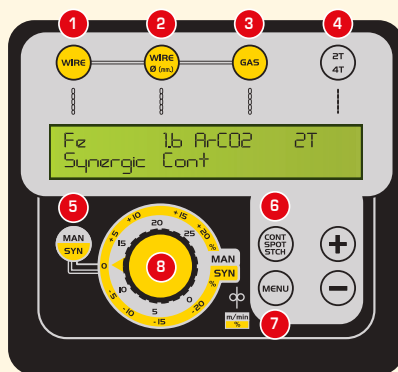

- 1 Selezione tipo di filo***
• Fe / Al / CuSi3 / Flux
- 2 Selezione diametro filo***
• 0,6 / 0,8 / 1,0 / 1,2 / 1,6
- 3 Selezione tipo di gas**
• Argon / Argon CO₂ / CO₂
- 4 Selezione modalità di saldatura:**
• 2 tempi (2T) / 4 tempi (4T)
- 5 Selezione Manuale/Sinergica**
- 6 Selezione modalità di saldatura:**
• Continuo / Spot (puntatura) / Stitch (tratteggio)
- 7 Accesso al sottomenu:**
• Burn Back / Rampa Soft Start / Tempo di pausa per la modalità stitch
- 8 - Regolazione fine velocità filo (+/- 20%)**

* Valori differenti a seconda dei modelli

- 1 Type wire selection***
• Fe / Al / CuSi3 / Flux
- 2 Diameter wire selection***
• 0,6 / 0,8 / 1,0 / 1,2 / 1,6
- 3 Gas type selection**
• Argon / Argon CO₂ / CO₂
- 4 Welding mode selection:**
• (2T - 4T)
- 5 Manual / Synergic welding selection**
- 6 Welding mode selection:**
• Continuous / Spot / Stitch
- 7 Menu access:**
• Burn Back / Soft Start / Pause time in stitch mode
- 8 - Fine wire speed regulation (+/- 20%)**

* Different values depending on the model



PORTA TORCIA
TORCH HOLDER

*Accessori in dotazione - Supplied accessories

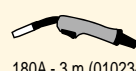

180A - 3 m (010234)



010311
16 mm² - 2,7 m



Gas 1,5 m



E
Ø 0,6 / 0,8 Fe
(010647)



MADE IN SAN MARINO		D-mig 520 T LAB	D-mig 525 T LAB	D-mig 530 S LAB	D-mig 520 SD LAB	D-mig 530 SD LAB	D-mig 525 TD LAB	
		MIG MAG			MIG MAG SYNERGIC			
Campo di regolazione - Welding current range		20 - 190A	20 - 220A	25 - 240A	30 - 180A	25 - 240A	20 - 220A	
Posizioni di saldatura - Welding positions		7	7	6	6	6	7	
Servizio 40°C - Duty cycle 40°C EN 60974-1		150A - 28%	170A - 45%	200A - 15%	140A - 15%	200A - 15%	170A - 45%	
		100A - 60%	140A - 60%	100A - 60%	75A - 60%	100A - 60%	140A - 60%	
Tensione a vuoto - Open circuit voltage		17,5 - 35V	17 - 34V	28 - 62V	28 - 53V	28 - 62V	17 - 34V	
Tensione di alimentazione - Input voltage		3 ph - 230/400V - 50/60 Hz			1 ph - 230V - 50/60 Hz		3 ph-230/400V - 50/60 Hz	
Potenza assorbita - Absorbed power:: 60% / Max		2,4 / 3,5 kW	3,5 / 5,3 kW	2,4 / 5,5 kW	1,6 / 3,9 kW	2,4 / 5,5 kW	3,5 / 5,3 kW	
Fusibile - Fuse		16/10A	16/10A	32A	16A	32A	16/10A	
Modalità - Mode		MANUAL			MANUAL - SYNERGIC			
Filo ø mm Wires ø mm	Acciaio - Steel	0,6 - 0,8 - 1,0			0,6 - 0,8 - 1,0			
	Inox	0,8 - 1,0			0,8 - 1,0			
	Al.Mg 5 - Al.Si 5	0,8 - 1,0			0,8 - 1,0			
	Cu.Si 3	0,8 - 1,0			0,8 - 1,0			
Bobina Ø mm - Wire spool Ø mm		200 - 300						
Trainafilo - Wire feeder		2 rulli - 2 rollers						
Connessioni in uscita - Output connection		DX 25 mmq / Euro						
Amperometro - Ammeter		-	-	-	•	•	•	
Voltmetro - Voltmeter		-	-	-	•	•	•	
Protezione termostatica - Thermostatic Protection		•	•	•	•	•	•	
Peso - Weight ≈		48,5 kg	52 kg	57 kg	47,5 kg	57 kg	52 kg	
Dimensioni - Dimensions		840 x 505 x 765 mm						
Versione - Version								
*Generatore + accessori - *Power source + accessories		258700	258800	258600	259000	259100	259200	
Accessori - Accessories MIG pag. 113								

Funzioni - Features							
Synergic / Simple Weld		-	-	-	•	•	•
Brazing		•	•	•	•	•	•
2T - 4T		-	-	-	•	•	•
Spot		•	•	•	•	•	•
Stich		-	-	-	•	•	•
Soft Start		•	•	•	•	•	•
Burn back		•	•	•	•	•	•



Optionals D-mig 5 LAB Series

Ø 100

010251
Aspo
Spool holder



010512 CO₂



010571 CO₂ → Ar





Carpenteria pesante
Heavy carpentry
Tubazioni
Pipe line

- Il controllo MIG Synergic facilita il lavoro del saldatore gestendo in sinergia con le altre impostazioni della saldatrice, la velocità del filo, la rampa iniziale ed il burn back. Il saldatore deve soltanto attivare uno dei programmi preimpostati
- Robuste ed affidabili
- Carrozzeria resistente
- The Synergic MIG control facilitates the welding machine operator's work as it manages wire speed, soft start and burn back in a synergic way with the rest of the machine settings. The welding machine operator must simply activate one of the pre-set programs.
- Sturdy and durable
- Tough housing

Simple Weld

Synergic Digital Control

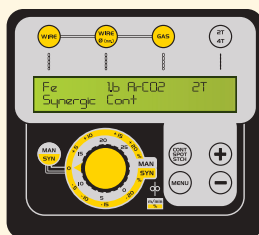

(pag. 62)

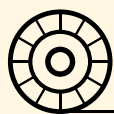

15 kg^{MAX}



TRAINAFILO A 4 RULLI INGRANATI D. 30
WIRE FEEDER WITH 4 GEARED ROLLERS D. 30



PORTA TORCIA
TORCH HOLDER

La proposta DECA per la carpenteria pesante. Solidi generatori tradizionali progettati per sostenere cicli intensivi di lavoro. **La serie 7 ha il trainafilo separato per costruzioni di grande dimensioni,** con possibilità di usare torce raffreddate ad acqua. Tutti i modelli esistono anche in versione sinergica, con auto-regolazione della velocità filo.

The DECA proposal for heavy carpentry. Solid traditional generators designed to support intensive work cycles. **The series 7 has a separated wire guide for large constructions,** with possible use of water-cooled torches. All models are also available in the synergic version, with self-regulated wire speed.

*D-mig 635 LAB Accessori in dotazione - Supplied accessories



230A - 3 m (010236)



010315
35 mm² - 3 m



Gas 1,5 m



Ø 0,8 / 1,0 Fe (011206)
Ø 1,2 / 1,6 Fe (011207)



340A - 3 m (010463)



010317
50 mm² - 3 m



Gas 1,5 m



Ø 0,8 / 1,0 Fe (011206)
Ø 1,2 / 1,6 Fe (011207)

*D-mig 650 - 660 LAB Accessori in dotazione - Supplied accessories



MADE IN SAN MARINO	D-mig 635 T LAB	D-mig 650 T LAB	D-mig 660 T LAB	D-mig 635 TD LAB	D-mig 650 TD LAB	D-mig 660 TD LAB
	MIG MAG			MIG MAG SYNERGIC		
Campi di regolazione - Welding current range	25 - 350A	30 - 500A	40 - 600A	25 - 350A	30 - 500A	40 - 600A
Posizioni di saldatura - Welding positions	10	21	30	10	21	30
Servizio 40°C - Duty cycle 40°C EN 60974-1	270A - 32%	410A - 33%	470A - 35%	270A - 32%	410A - 33%	470A - 35%
	200A - 60%	310A - 60%	360A - 60%	200A - 60%	310A - 60%	360A - 60%
Tensione a vuoto - Open circuit voltage	17 - 41V	17 - 49V	18 - 51V	17 - 41V	17 - 49V	18 - 51V
Tensione di alimentazione - Input voltage	3 ph - 230/400V - 50/60 Hz					
Potenza assorbita - Absorbed power: 60% /Max	5,5 / 8,5 kW	10 / 16 kW	13 / 20 kW	5,5 / 8,5 kW	10 / 16 kW	13 / 20 kW
Fusibile - Fuse	25/16A	50/32A	63/40A	25/16A	50/32A	63/40A
Modalità - Mode	MANUAL			SYNERGIC		MANUAL
Filo ø mm Wires ø mm	Filo animato - Flux cored	1,2 - 1,6		-		1,2 - 1,6
	Acciaio - Steel	0,8 - 1,0 - 1,2 - 1,6		0,8 - 1,0 - 1,2 - 1,6		-
	Inox	0,8 - 1,0 - 1,2 - 1,6		0,8 - 1,0 - 1,2 - 1,6		-
	Al.Mg 5 - Al.Si 5	1,0 - 1,2 - 1,6		1,0 - 1,2 - 1,6		-
Bobina Ø mm - Wire spool Ø mm	200 - 300					
Trainafilo - Wire feeder	4 rulli ingranati - 4 geared rollers					
Connessioni in uscita - Output connection	DX 70 mmq / Euro					
Amperometro - Ammeter	-	-	-	•	•	•
Voltmetro - Voltmeter	-	-	-	•	•	•
Protezione termostatica - Thermostatic Protection	•	•	•	•	•	•
Peso - Weight ≈	95 kg	122 kg	137 kg	95 kg	122 kg	137 kg
Dimensioni - Dimensions	870 x 540 x 1020 mm					
Versione - Version						
*Generatore + accessori - *Power source + accessories	262200	263700	263800	262600	263400	263600
Accessori - Accessories MIG pag. 113						

Funzioni - Features						
Synergic / Simple Weld	-	-	-	•	•	•
2T - 4T	•	•	•	•	•	•
Spot	•	•	•	•	•	•
Stitch	-	-	-	•	•	•
Soft Start	•	•	•	•	•	•
Burn back	•	•	•	•	•	•

Optionals D-mig 6 LAB Series

010512 CO₂ 010571 CO₂ → Ar



**TI SERVE ANCHE...
YOU ALSO NEED...**

MASCHERE
PER SALDATURA
WELDING
HELMETS

pag. 102

MMA

TIG

MIG

PAC

MMA

TIG

MIG

PAC

CAR BODY
REPAIR

Accessori
Accessories

Tech

Carpenteria pesante
Heavy carpentry
Tubazioni
Pipe line



- Il controllo MIG Synergic facilita il lavoro del saldatore gestendo in sinergia con le altre impostazioni della saldatrice, la velocità del filo, la rampa iniziale ed il burn back. Il saldatore deve soltanto attivare uno dei programmi preimpostati
- Robuste ed affidabili
- Carrozzeria resistente
- The Synergic MIG control facilitates the welding machine operator's work as it manages wire speed, soft start and burn back in a synergic way with the rest of the machine settings. The welding machine operator must simply activate one of the pre-set programs.
- Sturdy and durable
- Tough housing

Simple Weld

Synergic Digital Control

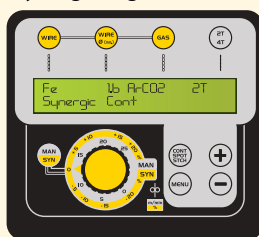

(pag. 62)



15 kg MAX



TRAINAFILO A 4 RULLI INGRANATI D. 30
WIRE FEEDER WITH 4 GEARED ROLLERS D. 30



PORTA TORCIA
TORCH HOLDER

*D-mig 735 LAB Accessori in dotazione - Supplied accessories



010315
35 mm² - 3 m



Ø 0,8 / 1,0 Fe (011206)
Ø 1,2 / 1,6 Fe (011207)

*D-mig 750 - 760 LAB Accessori in dotazione - Supplied accessories



010317
50 mm² - 3 m



Ø 0,8 / 1,0 Fe (011206)
Ø 1,2 / 1,6 Fe (011207)



MADE IN SAN MARINO			
	D-mig 735 TD LAB	D-mig 750 TD LAB	D-mig 760 TD LAB
Campo di regolazione - Welding current range	25 - 350A	30 - 500A	40 - 600A
Posizioni di saldatura - Welding positions	10	21	30
Servizio 40°C - Duty cycle 40°C EN 60974-1	270A - 32%	410A - 33%	470A - 35%
	200A - 60%	310A - 60%	360A - 60%
Tensione a vuoto - Open circuit voltage	17 - 41V	17 - 49V	18 - 51V
Tensione di alimentazione - Input voltage	3 ph - 230/400V - 50/60 Hz		
Potenza assorbita - Absorbed power: 60% /Max	5,5 / 8,5 kW	10 / 16 kW	13 / 20 kW
Fusibile - Fuse	25/16A	50/32A	63/40A
Conessioni in uscita - Output connection	DX 70 mmq		
Protezione termostatica - Thermostatic Protection	●	●	●
Peso - Weight ≈	84 kg	110 kg	125 kg
Dimensioni - Dimensions	920 x 540 x 940 mm		
Versione - Version			
Solo generatore - Power source only	266600	267800	268400



Trainafilo - Wire Feeder		WF4 LAB	WF4D LAB	
		MIG MAG	MIG MAG SYNERGIC	
Modalità - Mode		MANUAL	MANUAL	SYNERGIC
Filo ø mm Wires ø mm	Filo animato - Flux cored	1,2 - 1,6	1,2 - 1,6	-
	Acciaio - Steel	0,8 - 1,0 - 1,2 - 1,6	0,8 - 1,0 - 1,2 - 1,6	0,8 - 1,0 - 1,2 - 1,6
	Inox	0,8 - 1,0 - 1,2 - 1,6	0,8 - 1,0 - 1,2 - 1,6	0,8 - 1,0 - 1,2 - 1,6
	Al.Mg 5 - Al.Si 5	1,0 - 1,2 - 1,6	1,0 - 1,2 - 1,6	1,0 - 1,2 - 1,6
Bobina Ø mm - Wire spool Ø mm		200 - 300		
Trainafilo - Wire feeder		4 rulli ingranati - 4 geared rollers		
Connettore torcia - Torch connection		euro		
Amperometro - Ammeter		-	●	
Voltmetro - Voltmeter		-	●	
Peso - Weight ≈		13 kg	21,5 kg	
Dimensioni - Dimensions		550 x 260 x 480 mm	640 x 300 x 520 mm	
Versione - Version				
Solo trainafilo - Wire feeder only		269000	269200	
Accessori - Accessories MIG pag. 113				

Funzioni - Features		
Synergic / Simple Weld	-	●
2T/4T - Spot	●	●
Stitch	-	●
Soft Start - Burn Back	●	●
Predisposizione raffreddamento torcia ad acqua Equipped for torch water cooling system	●	●

Optionals D-mig 7 LAB Series

010512 CO₂

010571 CO₂ → Ar



Optionals WF 4 LAB

010067
WF 4 Kit Ruote
WF 4 Kit Wheels



MMA

TIG

MIG

PAC

MMA

TIG

MIG

PAC

CAR BODY
REPAIR

Accessori
Accessories

Tech



D-mig 735 TD LAB

266600



D-mig 750 TD LAB

267800



D-mig 760 TD LAB

268400



WF4 LAB

269000



WF4D LAB

MIG MAG - SYNERGIC

269200

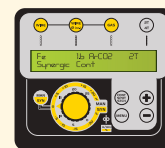

(pag. 62)

AIR



Cavi intermedi - Intermediary Cables

010105 3 m

010107 4 m

010109 9 m



D-mig 735 TD LAB

Torcia - Torch

010236 230A 3 m 230 @ 60%

010237 230A 4 m 230 @ 60%



D-mig 750 - 760 TD LAB

Torcia - Torch

010463 340A 3 m 340 @ 60%

010239 340A 4 m 340 @ 60%

H₂O



Cavi intermedi - Intermediary Cables H₂O

010106 3 m H₂O

010108 4 m H₂O

010110 9 m H₂O



Torcia - Torch H₂O CO₂ / Ar+CO₂

010461 3 m 500/450A @ 100%

010462 4 m 500/450A @ 100%



WU 16 LAB

010666 Impianto raffreddamento
Water cooling unit

PAC
Taglio al Plasma
Plasma Cutting

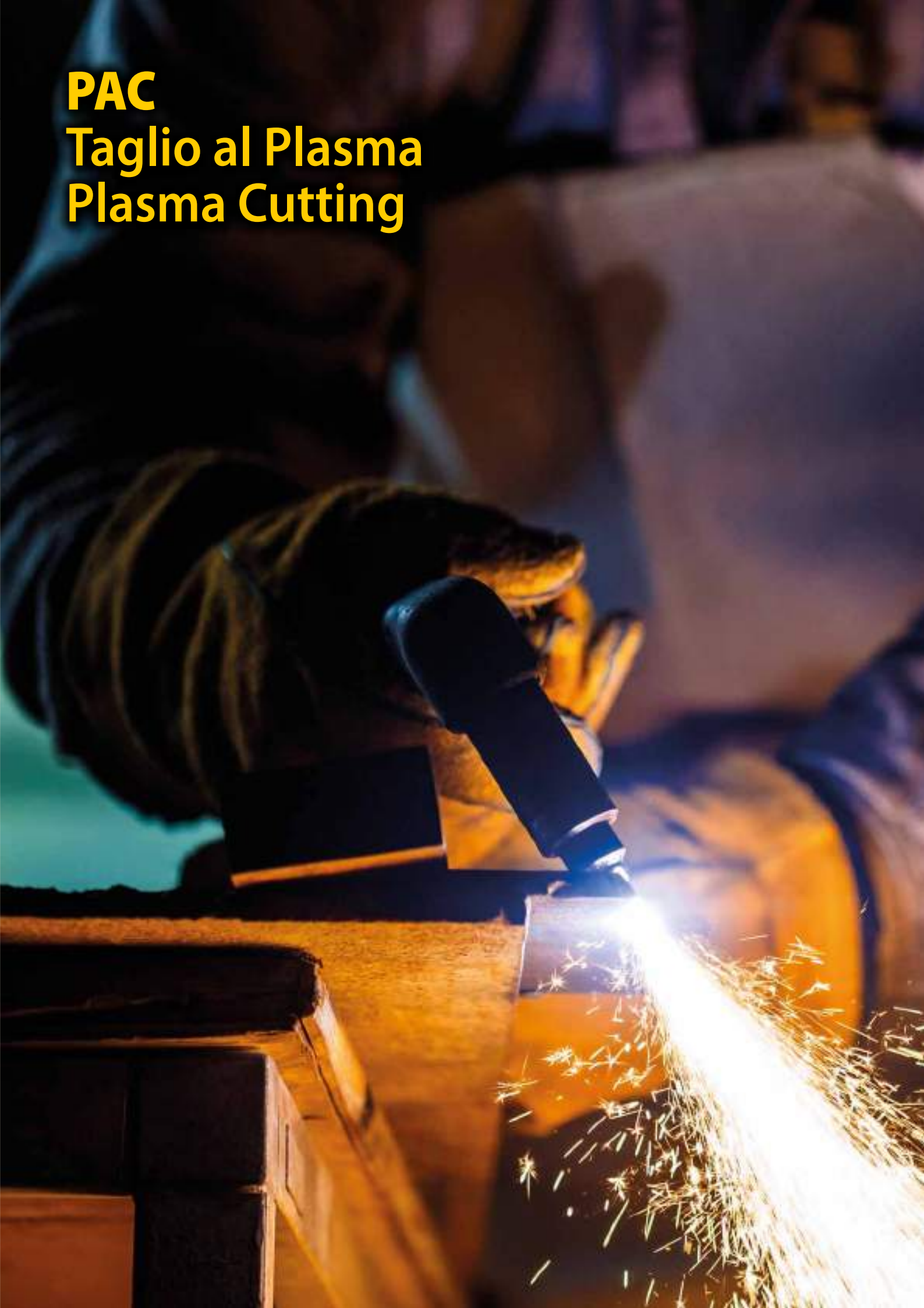

I-PAC 350 LAB

PAC INVERTER

NEW



Manutenzione
Maintenance

Carpenteria leggera
Light carpentry

Carpenteria pesante
Heavy carpentry

- Taglio plasma ad inverter con arco stabile ed ottima capacità di taglio
 - Taglio su grigliato
 - Arco pilota
 - Carrozzeria resistente
 - Compatte e maneggevoli
- Inverter plasma cutter with stable cutting arc and excellent cutting capacity
 - Cut on grid
 - Pilot arc
 - Tough housing
 - Compact and Handy

I-PAC 350 LAB

- RIDUTTORE DI PRESSIONE
- PRESSURE REDUCER



INCLUDED!



1 x Ø 0,9

2 x Ø 0,8

- SPECIALE GENERATORE
- GENERATOR USE

CONVAIR COOLING SYSTEM



- VENTILAZIONE AD ALTE PRESTAZIONI
- HIGH PERFORMANCE VENTILATION



Un impianto Taglio al Plasma a tecnologia inverter monofase, particolarmente performante, idoneo per spessori di lavoro tipici della media carpenteria.

A Plasma cutting system with single-phase inverter technology with remarkable performances, suitable for the thicknesses typical of medium carpentry.

*I-PAC 350 LAB Accessori in dotazione - Supplied accessories

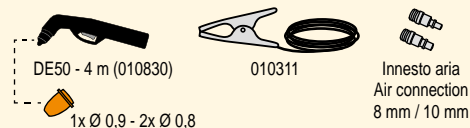

DE50 - 4 m (010830)

010311

Innesto aria
Air connection
8 mm / 10 mm

1x Ø 0,9 - 2x Ø 0,8



 MADE IN SAN MARINO	I-PAC 350 LAB	
Corrente di taglio - Cutting current	5 - 50A	
Servizio 40°C - Duty cycle 40°C EN 60974-1	45A - 25%	
	30A - 60%	
	23A - 100%	
Tensione a vuoto - Open circuit voltage	410V	
Tensione di alimentazione - Input voltage	1 ph - 230V - 50/60 Hz	
Potenza assorbita - Absorbed power: 60% / Max	3,0 / 5,5 kW	
Fusibile - Fuse	20A	
Generatore - Generator	+/- 30% (9kW)	
Taglio / Separazione* - Cut / Separation*	12 mm	20 mm
Pressione aria min/max - Air pressure min/max	3,5 - 5,0 bar	
Consumo aria - Air consumption	130 lt/min	
Connettore torcia - Torch connection	Centralizzata - Central connector	
Connettore massa - Earth connection	DX 25 mmq	
Protezione termostatica - Thermostatic Protection	●	
Peso - Weight	6,7 kg	
Dimensioni - Dimensions	435 x 160 x 273 mm	
Versione - Version		
*Generatore + accessori - *Power source + accessories	114800	
Accessori - Accessories PAC pag. 119		

Funzioni - Features

Taglio grigliato - Cut on grid	●
Arco pilota - Pilot arc	●
Ventilata - Fan cooled	Convair Cooling System
Allerta alimentazione - Power indicator light	●
Sistema di sicurezza torcia - Safety torch	●
Protezione termostatica - Thermostatic Protection	●



* Taglio / Cut



* Separazione / Separation

Optionals I-PAC 350 LAB

NEW

010084 KIT STARTER (pag.119)



010889 Carrello CR28 CR28 Trolley



**TI SERVE ANCHE...
YOU ALSO NEED...**

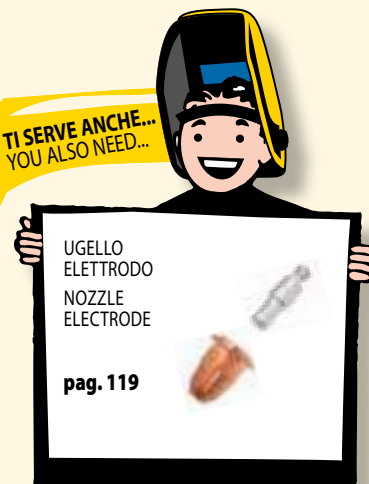

MMA

TIG

MIG

PAC

MMA

TIG

MIG

PAC

CAR BODY
REPAIR

Accessori
Accessories

Tech



Manutenzione
Maintenance

Carpenteria leggera
Light carpentry

Carpenteria pesante
Heavy carpentry

- Taglio plasma con arco stabile ed ottima capacità di taglio
- Taglio su grigliato
- Innescò ad alta frequenza
- Carrozzeria resistente

- Plasma cutter with stable cutting arc and excellent cutting capacity
- Cut on grid
- High frequency start
- Tough housing

*D-PAC 60 LAB Accessori in dotazione - Supplied accessories

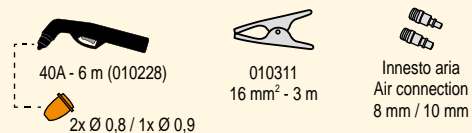

*D-PAC 90 LAB Accessori in dotazione - Supplied accessories

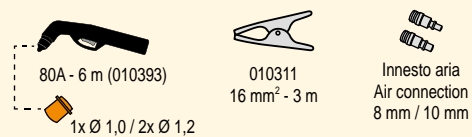

*D-PAC 120 LAB Accessori in dotazione - Supplied accessories

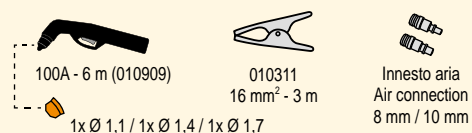

D-PAC è la gamma per il fabbro e la carpenteria media o pesante.
I due modelli più grandi hanno l'innescò ad alta frequenza.

D-PAC is the range for smiths and medium or heavy carpentry.
The two larger models have high frequency priming.



MADE IN SAN MARINO			
	D-PAC 60 LAB	D-PAC 90 LAB	D-PAC 120 LAB
Corrente di taglio - Cutting current	30-50A	40-80A	45-120A
Servizio 40°C - Duty cycle 40°C EN 60974-1	50A - 35%	75A - 30%	115A - 30%
	30A - 100%	40A - 100%	45A - 100%
Tensione a vuoto - Open circuit voltage	245V	265V	267V
Tensione di alimentazione - Input voltage	3 ph - 400V - 50/60 Hz		
Potenza assorbita - Absorbed power: Min / Max	3,0 / 5,5 kW	4,5 / 9,5 kW	5,2 / 17 kW
Fusibile - Fuse	16A	25A	50A
Taglio / Separazione* - Cut / Separation*	8 / 12 mm	15 / 20 mm	24 / 30 mm
Pressione aria min/max Air pressure min/max	5 - 6 bar		
Consumo aria - Air consumption	115 lt/min	155 lt/min	210 lt/min
Connettore torcia - Torch connection	Diretto - Direct	Diretto - Direct	Centralizzata - Central connector
Connettore massa - Earth connection	Diretto - Direct	Diretto - Direct	Diretto - Direct
Protezione termostatica Thermostatic Protection	•	•	•
Peso - Weight	52 kg	77 kg	89 kg
Dimensioni - Dimensions	560 x 504 x 770 mm	670 x 615 x 865 mm	
Versione - Version			
*Generatore + accessori *Power source + accessories	117500	117900	119300
Accessori - Accessories PAC pag. 120			

Funzioni - Features

Taglio grigliato - Cut on grid	-	•	•
Alta frequenza - High frequency	-	•	•
Allerta alimentazione - Power indicator light	•	•	•
Sistema di sicurezza torcia - Safety torch	•	•	•
Sistema raffreddamento Torcia Automatic torch cooling	•	•	•



* Taglio / Cut



* Separazione / Separation



MMA

TIG

MIG

PAC

MMA

TIG

MIG

PAC

CAR BODY
REPAIR

Accessori
Accessories

Tech

CAR BODY

MIG



SPOT



REPAIR



DENT PULLER



STUD ALU



MULTIPROCESS INVERTER

MODEL 2021



**Saldatura doppio pulsata
Double pulsed welding**

Manutenzione Autoriparazioni

- Saldatrice sinergica alto di gamma con programmi dedicati a molti materiali
- Programmi personalizzabili e memorizzabili
- SD-Card per aggiornare ed aggiungere programmi
- Regolazione completa dei parametri di saldatura
- Doppia versione: corrente liscia oppure con doppia pulsazione, per lavori perfetti su materiali particolari

Maintenance Automotive

- High-end synergic welder with programs dedicated to many materials
- Customizable and storable programs
- SD-Card to update and add programs
- Complete adjustment of the welding parameters
- Two version: conventional current or with double current pulsation for perfect works on particular metal

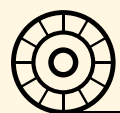

15 kg MAX



TRAINAFILO A 4 RULLI D. 37
WIRE FEEDER WITH 4 ROLLERS D. 37

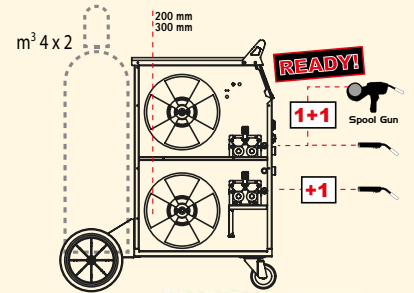

RUOTE INDUSTRIALI
HEAVY DUTY WHEELS

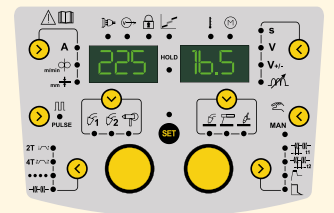

(pag. 52)

*Accessori in dotazione - Supplied accessories



180A - 3 m (010234)



2x Ø 0,6 / 0,8 Fe (011220)
2x Ø 0,8 / 1,0 Al (011222)



180A - 3 m (010234)



2x Ø 0,6 / 0,8 Fe (011220)



010311
16 mm² - 2,7 m



Gas 3 m



MADE IN SAN MARINO		JOB 523 LAB			JOB 523P LAB		
		MIG MAG	MMA	TIG	MIG MAG	MMA	TIG
Campo di regolazione - Welding current range		10 - 200A	10 - 160A	10 - 200A	10 - 200A	10 - 160A	10 - 200A
Servizio 40°C - Duty cycle 40°C EN 60974-1		200A - 25% 140A - 60%	160A - 30% 130A - 60%	200A - 30% 140A - 60%	200A - 25% 140A - 60%	160A - 30% 130A - 60%	200A - 30% 140A - 60%
Tensione a vuoto - Open circuit voltage		85V					
Tensione di alimentazione - Input voltage		1 ph - 230V - 50/60 Hz					
Potenza assorbita - Absorbed power: 60% / Max		3,0 / 6,0 kW					
Fusibile - Fuse		25A					
Modalità MIG- MIG Mode		MAN / SYN	-	-	MAN / SYN	-	-
Filo ø mm Wires ø mm	Acciaio - Steel Sg2 Sg3	0,6 - 0,8 - 1,0	-	-	0,6 - 0,8 - 1,0	-	-
	Inox AISI ER308 / ER316 / ER309	0,8 - 1,0	-	-	0,8 - 1,0	-	-
	Al.Mg 5%	0,8 - 1,0 - 1,2	-	-	0,8 - 1,0 - 1,2	-	-
	Al.Si 5%	1,0 - 1,2	-	-	1,0 - 1,2	-	-
	Cu.Si 3%	0,8 - 1,0 - 1,2	-	-	0,8 - 1,0 - 1,2	-	-
	Cu.Al 8%	0,8 - 1,0 - 1,2	-	-	0,8 - 1,0 - 1,2	-	-
Bobina ø mm- Wire spool ø mm		200 - 300 x 2					
Elettrodi : ø mm Electrodes: ø mm	Rutile / Basico Rutile / Basic	-	1,6 - 4,0	-	-	1,6 - 4,0	-
	TIG	-	-	1,0 - 4,0	-	-	1,0 - 4,0
Trainafile - Wire feeder		4 rulli x 2 - 4 rollers x 2			4 rulli x 2 - 4 rollers x 2		
Connessioni in uscita - Output connection		DX 25 mmq / Euro					
Amperometro - Ammeter / Voltmetro - Voltmeter		●			●		
Lettore SD Card - SD Card reader		●			●		
Protezione termostatica - Thermostatic Protection		●			●		
Peso - Weight =		42,5 kg			42,5 kg		
Dimensioni - Dimensions		860 x 560 x 1000 mm			860 x 560 x 1000 mm		
Versione - Version							
*Generatore + accessori - *Power source + accessories		250400			250800		
Accessori - Accessories MMA pag. 108 - TIG pag. 110 - MIG pag. 113							

Funzioni - Features	MIG MAG	MMA	TIG
Saldatura sinergica - Synergic welding	●	-	-
Saldatura pulsata - Pulsed welding	JOB 523P	-	-
Saldatura doppio pulsata-Double pulsed welding	JOB 523P	-	-
Induttanza elettronica - Electronic inductor	Regolabile - Adjustable	-	-
Caricamento filo - Wire loading	●	-	-
Test gas - Purge	●	-	-
Pregas - Postgas	●	-	-
2T - 4T / Spot / Stich	●	-	-
Burn back	Regolabile - Adjustable	-	-
Hot Start	Regolabile - Adjustable	Regolabile - Adjustable	-
Velocità avvicinamento filo - Wire approach speed	Regolabile - Adjustable	-	-
Arc Force	-	Regolabile - Adjustable	-
Anti-sticking	-	●	●
Tig Lift (Torch con rubinetto - TIG torch with gas valve)	-	-	●
Spool Gun	●	-	-
Torchia con potenziometro - Potentiometer torch	Autosetting	-	-
Memoria Programmi - Program saving	16	-	-

Optionals JOB 523 - 523P LAB

NEW 010068 KIT TIG TG17
Ø 1,6 WR2 acciaio-steel
(pag. 110)

140A - 4 m

NEW 010069
KIT
MMA
(pag. 112)

200A
+
16 mm² - 2,7 m
+
DX25 mm²

010571 CO₂ → Ar

010512 CO₂

010372
POT 3 180A 3 m
Torchia con potenziometro
Potentiometer torch
(pag. 114)

010374
Spool Gun 4
180A 6 m Euro
(pag. 115)

MMA
TIG
MIG
PAC
MMA
TIG
MIG
PAC
CAR BODY REPAIR
Accessories
Tech

MULTIPROCESS INVERTER

NEW 03/2021



Saldatura doppio pulsata
Double pulsed welding

Autoriparazioni

- Saldatrice sinergica alto di gamma con programmi dedicati a molti materiali
- Display grafico a colori con comandi semplici ed intuitivi
- Programmi personalizzabili e memorizzabili
- Programmi differenti per ogni torcia
- Richiamo programma attraverso il pulsante torcia
- SD-Card per aggiornare ed aggiungere programmi
- Regolazione completa dei parametri di saldatura
- Doppia versione: corrente liscia oppure con doppia pulsazione, per lavori perfetti su materiali particolari

Automotive

- High-end synergic welder with programs dedicated to many materials
- Color graphic display with simple and intuitive user interface
- Customizable and storable programs
- Different programs for each torch
- Programs recall via torch trigger
- SD-Card to update and add programs
- Complete adjustment of the welding parameters
- Two version: conventional current or with double current pulsation for perfect works on particular metal

(pag. 53)

5 kg MAX



TRAINAFILO A 4 RULLI D. 37
WIRE FEEDER WITH 4 ROLLERS D. 37

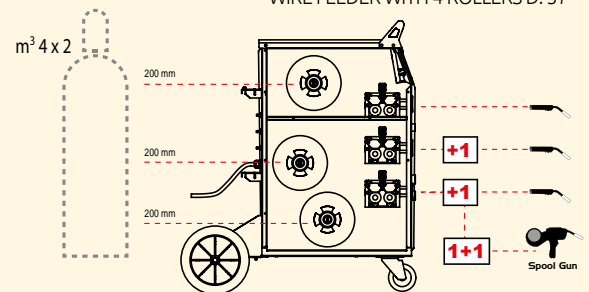

RUOTE INDUSTRIALI
HEAVY DUTY WHEELS

*Accessori in dotazione - Supplied accessories

- | | |
|--|----------------------------|
| | C |
| 230A - 3 m (010074)
Alu Ø 1,0 ready | 2x Ø 0,8 / 1,0 Al (011222) |
| | C |
| 180A - 3 m (010234)
Fe Ø 0,8 ready | 2x Ø 0,6 / 0,8 Fe (011220) |
| | C |
| 180A - 3 m (010071)
CuSi ₃ Ø 0,8 ready | 2x Ø 0,6 / 0,8 Fe (011220) |
| | |
| 010311
16 mm ² - 2,7 m | Gas 3 m |



Double pulsed

MADE IN SAN MARINO		JOB 524 T3 LAB		
		MIG MAG	MMA	TIG
Campo di regolazione - Welding current range		10 - 200A	10 - 160A	10 - 200A
Servizio 40°C - Duty cycle 40°C EN 60974-1		200A - 25%	160A - 30%	200A - 30%
Tensione a vuoto - Open circuit voltage		140A - 60%	130A - 60%	140A - 60%
Tensione di alimentazione - Input voltage		1 ph - 230V - 50/60 Hz		
Potenza assorbita - Absorbed power: 60% / Max		3,0 / 6,0 kW		
Fusibile - Fuse		25A		
Modalità MIG- MIG Mode		MAN / SYN	-	-
Filo ø mm Wires ø mm	Acciaio - Steel Sg2 Sg3	0,6 - 0,8 - 1,0	-	-
	Inox AISI ER308 / ER316 / ER309	0,8 - 1,0	-	-
	Al.Mg 5%	0,8 - 1,0 - 1,2	-	-
	Al.Si 5%	1,0 - 1,2	-	-
	Cu.Si 3%	0,8 - 1,0 - 1,2	-	-
	Cu.Al 8%	0,8 - 1,0 - 1,2	-	-
Bobina Ø mm- Wire spool Ø mm		200 x 3		
Elettrodi : ø mm Electrodes: ø mm	Rutile / Basico Rutile / Basic	-	1,6 - 4,0	-
	TIG	-	-	1,0 - 4,0
	Trainafile - Wire feeder	4 rulli x 3 - 4 rollers x 3		
Connessioni in uscita - Output connection		DX 25 mmq / Euro		
Amperometro - Ammeter / Voltmetro - Voltmeter		●		
Lettore SD Card - SD Card reader		●		
Protezione termostatica - Thermostatic Protection		●		
Peso - Weight ≈		50 kg		
Dimensioni - Dimensions		860 x 560 x 1000 mm		
Versione - Version				
*Generatore + accessori - *Power source + accessories		250100		
Accessori - Accessories MMA pag. 108 - TIG pag. 110 - MIG pag. 113				

Funzioni - Features	MIG MAG	MMA	TIG
Saldatura sinergica - Synergic welding	●	-	-
Saldatura pulsata - Pulsed welding	●	-	-
Saldatura doppio pulsata-Double pulsed welding	●	-	-
Induttanza elettronica - Electronic inductor	Regolabile - Adjustable	-	-
Caricamento filo - Wire loading	●	-	-
Test gas - Purge	●	-	-
Lettore SD Card - SD Card reader	●	-	-
Pregas - Postgas	●	-	-
2T/4T / Spot / Stich	●	-	-
Burn back	Regolabile - Adjustable	-	-
Hot Start	Regolabile - Adjustable	Regolabile - Adjustable	-
Velocità avvicinamento filo - Wire approach speed	Regolabile - Adjustable	-	-
Arc Force (MMA)	-	Regolabile - Adjustable	-
Anti-sticking (MMA/TIG)	-	●	●
Tig Lift (Torchia con rubinetto - Torch with gas valve)	-	-	●
Spool Gun	●	-	-
Torchia con potenziometro - Potentiometer torch	●	-	-
Memoria Programmi - Program saving	16	-	-

Optionals JOB 524 T3 LAB

<p>NEW 010068 KIT TIG TG17 Ø 1,6 WR2 acciaio-steel (pag. 110)</p> <p>140A - 4 m</p>	<p>NEW 010069 KIT MMA (pag. 112)</p> <p>200A 16 mm² - 2,7 m DX25 mm²</p>	<p>010571 CO₂ → Ar</p> <p>010512 CO₂</p>	<p>010372 POT 3 180A 3 m Torchia con potenziometro Potentiometer torch (pag. 114)</p>	<p>010374 Spool Gun 4 180A 6 m Euro (pag. 115)</p>	<p>NEW Ø 100</p> <p>010399 Aspo Spool holder</p>
--	---	--	---	--	---

MMA

TIG

MIG

PAC

MMA

TIG

MIG

PAC

CAR BODY REPAIR

Accessori Accessories

Tech

D-mig 532 TDK E LAB

MIG NO
MAG GAS

MIG TRADITIONAL



Autoriparazioni
Automotive

- Il controllo MIG Synergic facilita il lavoro del saldatore gestendo in sinergia con le altre impostazioni della saldatrice, la velocità del filo, la rampa iniziale ed il burn back. Il saldatore deve soltanto attivare uno dei programmi preimpostati

- Robuste ed affidabili
- Carrozzeria resistente

- The Synergic MIG control facilitates the welding machine operator's work as it manages wire speed, soft start and burn back in a synergic way with the rest of the machine settings. The welding machine operator must simply activate one of the pre-set programs.

- Sturdy and durable
- Tough housing

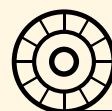

5 kg MAX

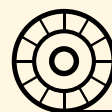

15 kg MAX

Simple Weld

Synergic Digital Control

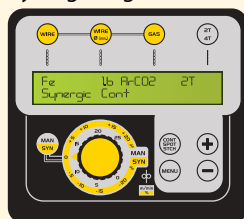

(pag. 62)

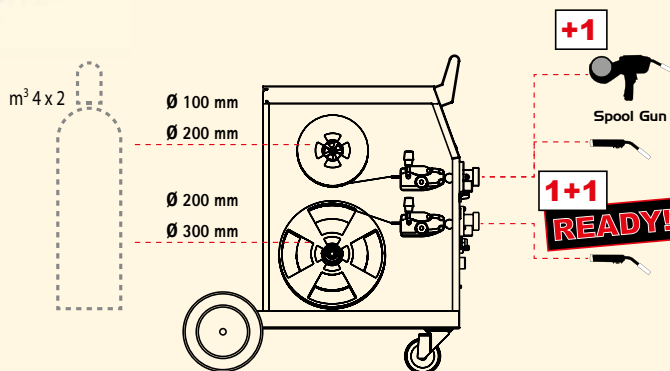

*Accessori in dotazione - Supplied accessories



180A - 3 m (010234)



Ø 0,6 / 0,8 Fe (011647)



180A - 3 m (010234)



Ø 0,6 / 0,8 Fe (011647)



010311
16 mm² - 2,7 m



Gas 3 m



MADE IN SAN MARINO		D-mig 532 TDK E LAB	
		MIG MAG SYNERGIC	
Campo di regolazione - Welding current range		20 - 220A	
Posizioni di saldatura - Welding positions		10	
Servizio 40°C - Duty cycle 40°C EN 60974-1		160A - 45%	
		140A - 60%	
Tensione a vuoto - Open circuit voltage		16,5 - 32V	
Tensione di alimentazione - Input voltage		3 ph-230/400V- 50/60 Hz	
Potenza assorbita - Absorbed power: 60% / Max		3,4 / 5,0 kW	
Fusibile - Fuse		16/10A	
Modalità - Mode		MANUAL	SYNERGIC
Filo ø mm Wires ø mm	Acciaio - Steel	0,6 - 0,8 - 1,0	0,6 - 0,8 - 1,0
	Inox	0,8 - 1,0	0,8 - 1,0
	Al.Mg - Al.Si	0,8 - 1,0	0,8 - 1,0
	Cu.Si - Cu.Al	0,8 - 1,0	0,8 - 1,0
Bobina Ø mm- Wire spool Ø mm		(100 - 200) / (200 - 300)	
Trainafile - Wire feeder		2 rulli -2 rollers x2	
Connessioni in uscita - Output connection		DX 25 mmq / Euro	
Amperometro Voltmetro - Ammeter / Voltmeter		●	
Protezione termostatica - Thermostatic Protection		●	
Peso - Weight ≈		65 kg	
Dimensioni - Dimensions		845 x 505 x 780 mm	
Versione - Version			
*Generatore + accessori - *Power source + accessories		259500	
Accessori - Accessories MIG pag. 113			

Funzioni - Features	
Synergic / Simple Weld	●
Brazing	●
2T - 4T	●
Spot	●
Stitch	●
Soft Start	●
Burn back	●
Spool Gun	●
Torcia con potenziometro - Potentiometer torch	●

Optionals D-mig 532 TDK E LAB

 010372 POT 3 180A 3 m Torcia con potenziometro Potentiometer torch (pag. 114)	 010374 Spool Gun 4 180A 6 m Euro (pag. 115)	 Ø 100 010251 Aspo Spool holder	 010512 CO ₂	 010571 CO ₂ → Ar
---	--	--	--	--

MMA

TIG

MIG

PAC

MMA

TIG

MIG

PAC

CAR BODY REPAIR

Accessori Accessories

Tech

RESISTANCE WELDER



SW 100 LAB

Pannello Sinergico - Synergic Panel

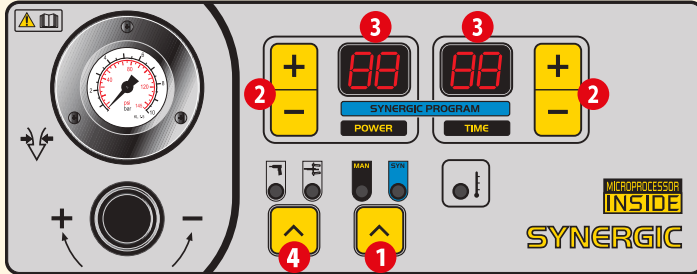

SYNERGIC

1 REGOLAZIONE SINERGICA

Regola automaticamente i parametri di saldatura in base all'utensile selezionato ed allo spessore da saldare.

SYNERGETIC ADJUSTMENT

Automatically sets the welding parameters according to the selected tool and the workpiece thickness.

2 Regolazione personalizzabile del tempo e della corrente di lavoro.

Adjustable time and spot welding current.

3 Strumento digitale per la regolazione fine.

Two-digit instrument for adjustable welding current setting.

4 Utilizzo contemporaneo di una pinza puntatrice ed uno studder allo scopo eliminare i tempi di cambio utensile.

Possibility of using at the same time a spot gun and a studder gun in order to avoid any waste of time in tools fitting up.

PULSE GALVANISED STEEL

PULSE Galvanised Steel

Puntatura a punto singolo e punto singolo pulsato per lamiere ad alto limite di snervamento e lamiere zincate.

PULSE Galvanised Steel

Continuous single spot and pulsed single spot for sheet metals high yield strength and galvanized steel.

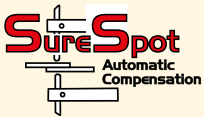

SURE SPOT Automatic Compensation

La Compensazione automatica assicura l'uniformità di tutti i punti di saldatura.

SURE SPOT Automatic Compensation

Automatic compensation grants all welding spots evenness.

Programmi Sinergici - Synergic Program

TOOL	N° Prg.	PULSE High yield Strength steel		PULSE Galvanized Steel	
		mm. $\frac{3}{8}$ $\frac{1}{2}$	N° Prg.	mm. $\frac{3}{8}$ $\frac{1}{2}$	N° Prg.
	32	0.5 + 0.5	16	0.5 + 0.5	25
	33	0.6 + 0.6	17	0.6 + 0.6	26
	34	0.8 + 0.8	18	0.8 + 0.8	27
	35	1.0 + 1.0	19	1.0 + 1.0	28
	36	1.2 + 1.2	20	1.2 + 1.2	29
	37	1.5 + 1.5	21	1.5 + 1.5	30
	38	2.0 + 2.0	22	2.0 + 2.0	31
	39	2.5 + 2.5	23		
		3.0 + 3.0	24		
		1.2 + 1.2 + 1.2	10		
		2.0 + 2.0	11		
		1.5 + 1.5 + 1.5	12		
		2.5 + 2.5	13		
		2.0 + 2.0 + 2.0	14		
		3.0 + 3.0	15		

AIR
5 / 6 bar
72 / 87 psi



SW 18 - 28 - 58 LAB

SW 18 LAB

La soluzione pratica - The practical solution.

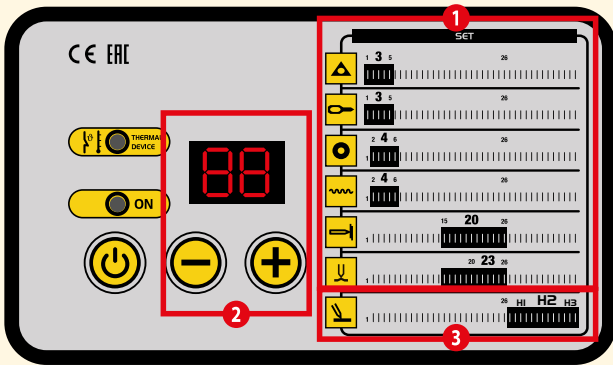

L'interfaccia utente è stata semplificata al massimo per favorire la velocità di apprendimento da parte dell'utilizzatore.

Occorre regolare soltanto il tempo di saldatura in base al tipo di elettrodo usato, come indicato nella tabella parametri sul frontale.

- 1 Tempo saldatura consigliato in base alle applicazioni indicate
- 2 Regolazione tempo saldatura
- 3 Funzione scaldalamiera con tre diversi livelli di potenza

The user interface is simplified to facilitate the learning of the operator.

Only one parameter setting, the welding time, according to the type of electrode, as shown in the parameters table on the front panel.

- 1 Recommended welding time for each application
- 2 Welding time adjustment
- 3 Graphite electrode function with three different power levels

SW 28 LAB

La soluzione completa - The complete solution

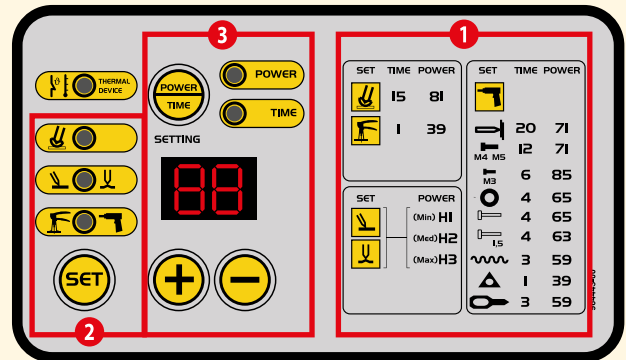

L'utilizzatore può regolare potenza e tempo di saldatura, seguendo la tabella parametri. Sono disponibili anche i programmi automatici specifici per elettrodo scaldalamiera, rappazzatura con corrente pulsata.

- 1 Potenza e tempo di saldatura consigliati in base alle applicazioni indicate
- 2 Selezione tipo saldatura: Corrente pulsata, continua, punto singolo
- 3 Selezione e regolazione della potenza e del tempo di saldatura

The operator can adjust the welding power and time, as shown in the parameters table on the front panel. Specific automatic programs are available for carbon heating electrodes, for electrode wheels with pulsed current.

- 1 Recommended power and welding time for each application
- 2 Welding type selection: Pulsed and continuous current, single point
- 3 Power and welding time selection and adjustment.

SW 58 LAB

La soluzione più efficiente - The most efficient solution

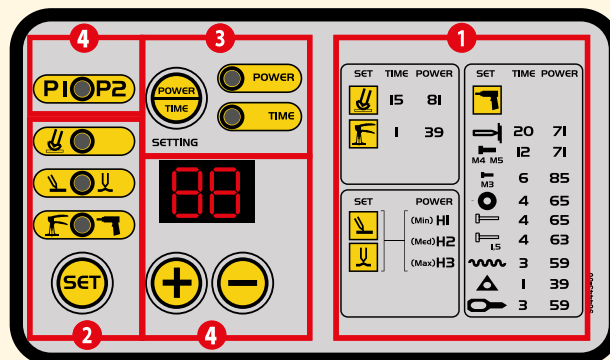

Due pistole con differenti programmi di lavoro. Una pistola con innescò dell'arco a contatto ed una pistola comandata attraverso il grilletto. L'utilizzatore può regolare potenza e tempo di saldatura seguendo la tabella parametri. Sono disponibili programmi automatici specifici per elettrodo scaldalamiera e rappazzatura con corrente pulsata.

- 1 Potenza e tempo di saldatura consigliati in base alle applicazioni indicate
- 2 Selezione tipo saldatura: Corrente pulsata, continua, punto singolo
- 3 Selezione e regolazione della potenza e del tempo di saldatura
- 4 Indicazione della pistola selezionata e del programma in uso

Two guns with different setting. A gun with contact arc ignition and a gun with trigger controlled arc ignition. The operator can adjust the welding power and time as shown in the parameters table on the front panel.

Specific automatic programs are available for carbon heating electrodes, for electrode wheels with pulsed current.

- 1 Recommended power and welding time for each application
- 2 Welding type selection: pulsed or continuous current, single point.
- 3 Power and welding time selection and adjustment
- 4 Indication of the selected gun and the setting in use

SW 100 LAB

RESISTANCE WELDER - DENT PULLER

MODEL 2021

Autoriparazioni
Automotive
Carpenteria leggera
Light carpentry

8000A

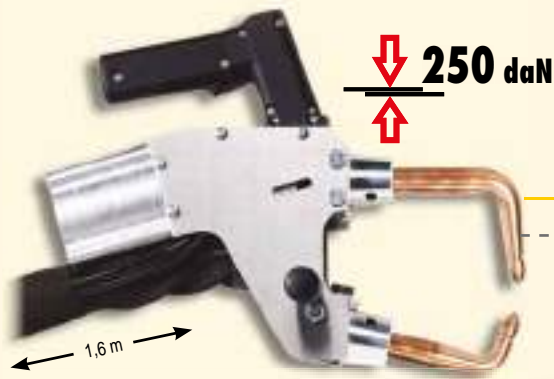

*Accessori in dotazione

*Supplied accessories

Impianti per la puntatura di lamiere in acciaio per carrozzeria auto.
Estremamente potenti e, al contempo, semplici da usare, consentono la riparazione della carrozzeria e della struttura dei veicoli tramite l'unione di lamiere sovrapposte.

Spot welding systems for car steel bodywork. Extremely powerful and at the same time, easy to use, they allow the repair of the bodywork and vehicles frame through the welding of overlapping plates.

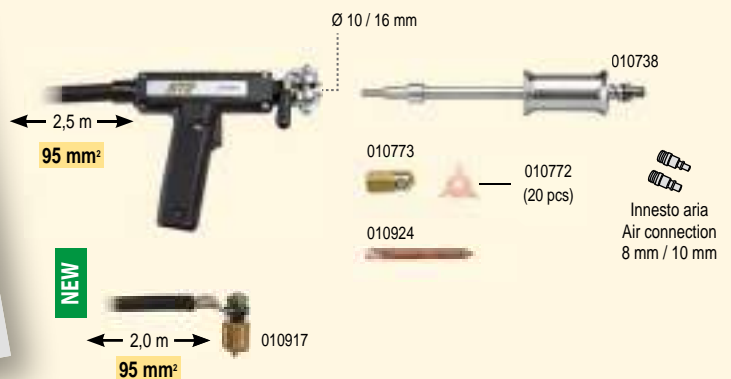



 MADE IN SAN MARINO		SW 100 LAB
		SYNERGIC
Campo di regolazione - Welding current range (I RMS)		200-8000A
Tensione a vuoto - Open circuit voltage		0,8 - 10,1V in 99 steps
Capacità di saldatura - Welding capacity		3 + 3 mm
Punti/ora - Spots/Hour	0,8 + 0,8 mm	600
Punti/ora - Spots/Hour	3 + 3 mm	75
Tensione di alimentazione - Input voltage		1 ph - 400V 50/60 Hz
Potenza di installazione - Installation power		11,2 kW - 50% 47,0 kW - 100%
Fusibile - Fuse		32A (D)
Metalli saldabili - Weldable Metals		Acciaio, inox - Steel, inox
Riduttore di pressione integrato Pressure reducer included		•
Carrello completo di braccio - Trolley complete with arm support		•
Trasformatore in rame - Copper Transformer		•
Protezione termostatica - Thermostatic Protection		•
Peso - Weight ≈		85 kg
Dimensioni - Dimensions		725 x 650 x 1060 mm
Versione - Version		
*Generatore + accessori - *Power source + accessories		276600
Accessori - Accessories pag. 94 - 100		

Funzioni - Features		
Synergic		•
Pulse		•
Sure Spot		•
Monopunto / Single spot		•
Tabella parametri - Parameters chart		•
Predisposizione raffreddamento torcia ad acqua Equipped for torch water cooling system		•

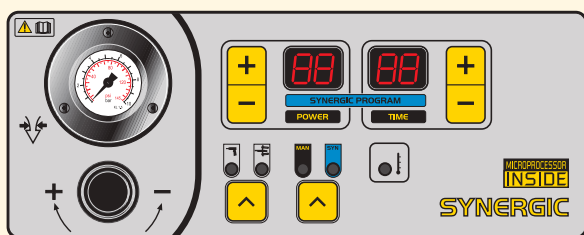

(pag. 82)

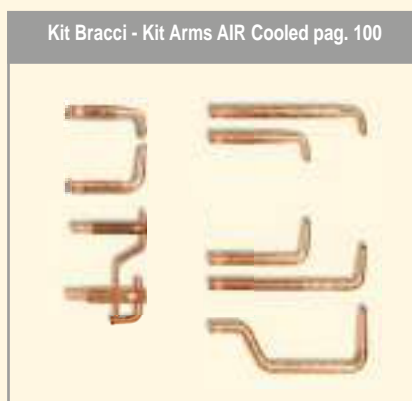

MMA

TIG

MIG

PAC

MMA

TIG

MIG

PAC

CAR BODY REPAIR

Accessori Accessories

Tech

DENT PULLER

NEW



Autoriparazioni Automotive ACCIAIO STEEL

- Riparazione di ammaccature e raddrizzamento di lamiere sottili
 - Differenti funzioni per tanti utilizzi della carrozzeria
 - Facile da usare: la regolazione del tempo e della potenza è indicata in una tabella di aiuto
 - Pistola con grilletto: il punto di saldatura è comandato attraverso il grilletto.
- Repair of dents and straightening of thin metal sheets
 - Different functions for many uses on carbody repair
 - Easy to use: time and power settings are indicated in a help table
 - Gun with trigger: the welding point is controlled through the trigger.

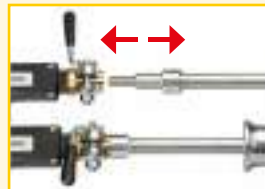

QUICK LINK !

*Accessori in dotazione

*Supplied accessories



* SW 18 LAB
Kit Studder

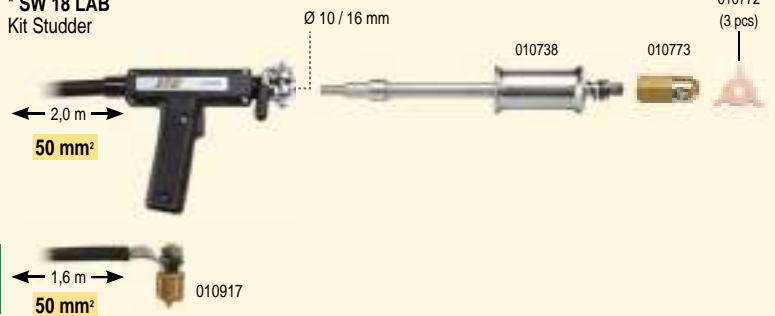

* SW 28 LAB
Kit Studder

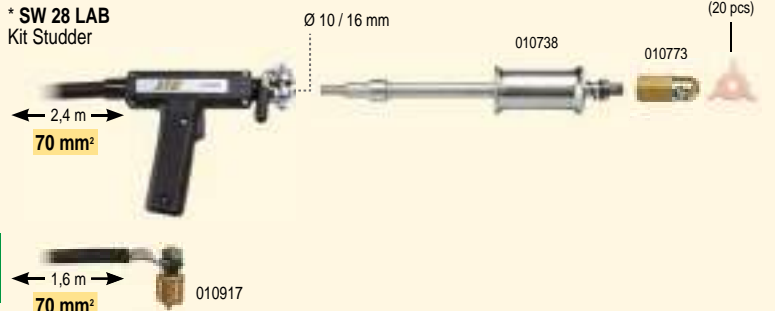



MADE IN SAN MARINO	SW 18 LAB	SW 28 LAB
Campo di regolazione - Welding current range (I ₂ MAX)	3200A	4500A
Campo di regolazione - Welding current range (I RMS)	1600A	400-2800A
Tensione a vuoto - Open circuit voltage	5,8V	2,4 - 7,4V in 50 steps
Tensione di alimentazione - Input voltage	1 ph - 220/240V 50/60 Hz	1 ph - 230V 50/60 Hz
Potenza assorbita - Absorbed power: 50% / Max	1,5 / 3 kW	2,7 / 4 kW
Fusibile - Fuse	16A	
Metalli saldabili - Weldable Metals	Acciaio, inox, zincato - Steel, inox, galvanized steel	
Trasformatore in Rame - Copper Transformer	-	●
Protezione termostatica - Thermostatic Protection	●	●
Peso - Weight ≈	16,6 kg	20 kg
Dimensioni - Dimensions	315 x 186 x 258 mm	315 x 186 x 258 mm
Versione - Version		
*Generatore + accessori - *Power source + accessories	273000	270600
Accessori - Accessories pag. 94		

Funzioni - Features

Regolazione potenza saldatura - Power setting	-	●
Regolazione tempo saldatura - Time setting	●	●
Tabella parametri saldatura - Welding parameters chart	●	●
Saldatura punto singolo - Single spot welding	●	●
Saldatura punto pulsato - Pulsed spot welding	-	●
Saldatura continua - Continuous spot welding	-	●
Elettrodo scaldalamiere - Carbon heating electrode	●	●

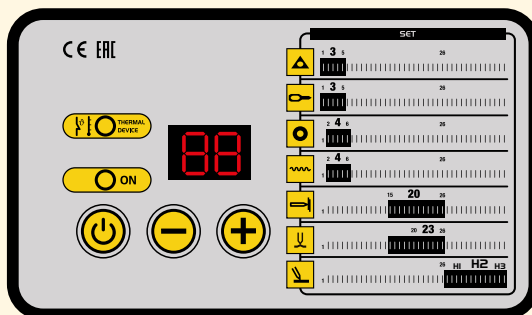

SW 18 LAB
(pag. 83)

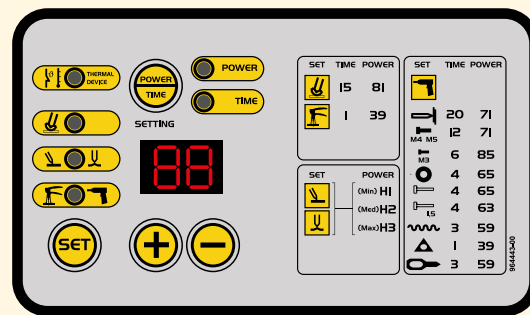

SW 28 LAB
(pag. 83)

Optionals

010889
Carrello CR28
CR28 Trolley



Accessori
Accessories
pag. 94



MMA

TIG

MIG

PAC

MMA

TIG

MIG

PAC

CAR BODY
REPAIR

Accessori
Accessories

Tech

DENT PULLER

NEW 03/2021

Pistola con innesco a contatto
50 mm² - 3 m
Contact gun
50 mm² - 3 m

Ø 10 / 16 mm

Pistola con grilletto
70 mm² - 2,4 m
Gun with trigger
70 mm² - 2,4 m



4500A

INCLUDED!

010093 KST1 Kit Tiro - Puller Kit

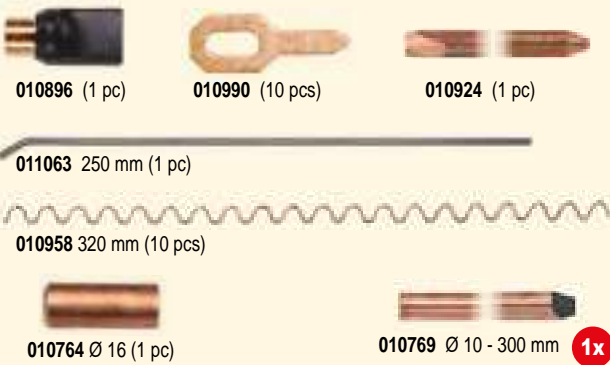

Special Kit
pag. 85

Autoriparazioni
Automotive

ACCIAIO STEEL

- Riparazione di ammaccature e raddrizzamento di lamiere sottili
- Differenti funzioni per tanti utilizzi della carrozzeria
- Facile da usare: la regolazione del tempo e della potenza è indicata in una tabella di aiuto
- Massima comodità di lavoro con due pistole con differenti regolazioni
- Pistola con innesco a contatto: il punto di saldatura si genera appena l'utensile è a contatto con il pezzo da raddrizzare
- Pistola con grilletto: il punto di saldatura è comandato attraverso il grilletto.
- Repair of dents and straightening of thin metal sheets
- Different functions for many uses on carbody repair
- Easy to use: time and power settings are indicated in a help table
- Maximum working comfort with two guns with different settings
- Contact gun: the welding point is generated as soon as the tool is in contact with the piece to be straightened
- Gun with trigger: the welding point is controlled through the trigger.

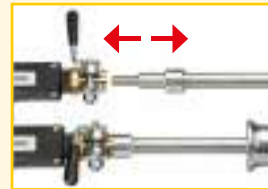

QUICK LINK !



Spotter controllati a microprocessore per la riparazione di carrozzerie in acciaio tramite saldatura a resistenza di rondelle, perni e filo ondulato sulla lamiera e successivo tiraggio della stessa. Articoli indispensabili in ogni carrozzeria, affidabili e semplici da usare.

Microprocessor controlled Spotter/Dent Puller for repairing steel car bodies, by resistance welding of pulling rings, studs and wavy wire. Essential items in every body shop, reliable and simple to use.

*Accessori in dotazione

*Supplied accessories

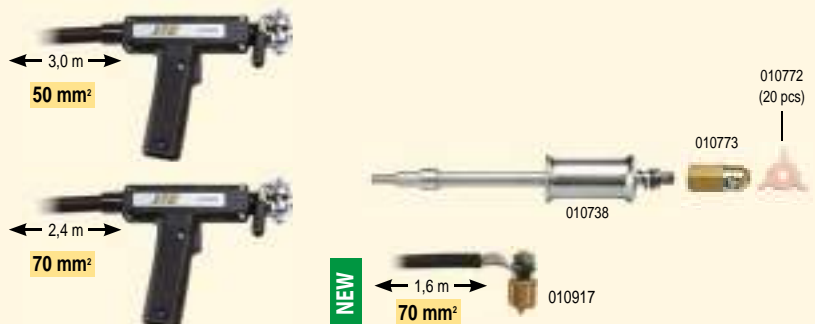



MADE IN SAN MARINO	SW 58 LAB
Campo di regolazione - Welding current range (I _z MAX)	4500A
Campo di regolazione - Welding current range (I RMS)	400-2800A
Tensione a vuoto - Open circuit voltage	2,4 - 7,4V in 50 steps
Tensione di alimentazione - Input voltage	1 ph - 230V 50/60 Hz
Potenza assorbita - Absorbed power 50% / Max	2,7 / 4 kW
Fusibile - Fuse	16A
Metalli saldabili - Weldable Metals	Acciaio, inox, zincato - Steel, inox, galvanized steel
Trasformatore in Rame - Copper Transformer	●
Protezione termostatica - Thermostatic Protection	●
Peso - Weight ≈	21 kg
Dimensioni - Dimensions	340 x 218 x 258 mm
Versione - Version	
*Generatore + accessori - *Power source + accessories	274100
Accessori - Accessories pag. 94	

Funzioni - Features

Regolazione potenza saldatura - Power setting	●
Pistola con innesco a contatto - Contact gun	●
Pistola con grilletto - Gun with trigger	●
Regolazione tempo saldatura - Time setting	●
Tabella parametri saldatura - Welding parameters chart	●
Saldatura punto singolo - Single spot welding	●
Saldatura punto pulsato - Pulsed spot welding	●
Saldatura continua - Continuous spot welding	●
Elettrodo scaldalamiere - Carbon heating electrode	●
Pistola attacco rapido - Gun with quick connection	●

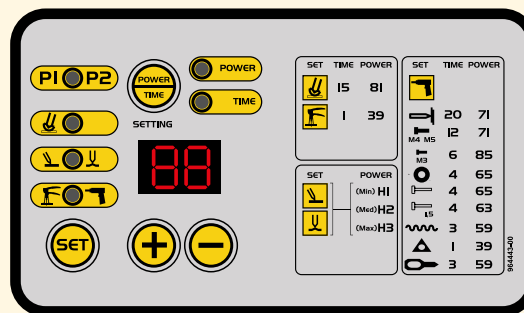

SW 58 LAB (pag. 83)

Optionals

010889
Carrello CR28
CR28 Trolley



Accessori
pag. 94



MMA

TIG

MIG

PAC

MMA

TIG

MIG

PAC

CAR BODY
REPAIR

Accessori
Accessories

Tech

Pull-ARC 250

DRAWN ARC INVERTER

MODEL 2021



Autoriparazioni
Automotive

Carpenteria leggera
Light carpentry

ALLUMINIO

ALUMINIUM

ACCIAIO

STEEL

- Saldatrice sinergica alto di gamma con programmi dedicati ad alluminio ed acciaio.
- Riparazione di ammaccature e raddrizzamento di lamiere sottili specialmente di alluminio
- Differenti funzioni per tanti utilizzi della carrozzeria
- Display grafico a colori con comandi semplici ed intuitivi
- Programmi personalizzabili e memorizzabili
- SD-Card per aggiornare ed aggiungere programmi
- Facile e veloce da usare non richiede gas

- High-end synergic welder with programs dedicated to aluminium and steel
- Repair of dents and straightening of thin metal sheets especially aluminium
- Different functions for many uses on carbody repair
- Color graphic display with simple and intuitive user interface
- Customizable and storable programs
- SD-Card to update and add programs
- Quick and easy to use, it does not require gas .



*Accessori in dotazione

*Supplied accessories



Spotter controllato a microprocessore per la riparazione di carrozzerie in alluminio, tramite saldatura ad arco corto di rondelle asolate e perni in corrispondenza delle ammaccature e successivo tiraggio con apposite traverse.

Sistema innovativo, molto pratico da usare.

Microprocessor controlled spotter for repairing aluminium bodywork, with short arc welding of pulling rings and studs at the dents and successive pulling with specific crossbars.

Innovative system, very simple to use.

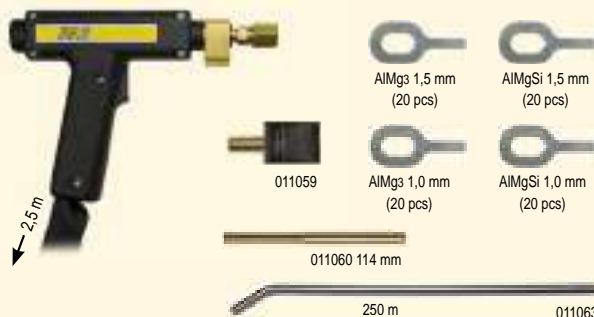



 MADE IN SAN MARINO	Pull-ARC 250 LAB
Campo di regolazione - Welding current range (I RMS)	50-200A
Tensione a vuoto - Open circuit voltage	75V
Metalli saldabili - Weldable Metals	AlMg3 - AlMgSi - Acciaio, inox, zincato - Steel, inox, galvanized steel
Tensione di alimentazione - Input voltage	1 ph - 230V 50/60 Hz
Potenza assorbita - Power absorption: Max	300W
Fattore di potenza - Power factor	0,8
Rendimento - Efficiency	90%
Fusibile - Fuse	16A
Protezione termostatica - Thermostatic Protection	●
Peso - Weight ≈	5,5 kg
Dimensioni - Dimensions	370 x 160 x 274 mm
Versione - Version	
*Generatore + accessori - *Power source + accessories	272700
Pull ARC Basic Kit	272791
Accessori - Accessories pag. 96	

MMA

TIG

MIG

PAC

MMA

TIG

MIG

PAC

CAR BODY REPAIR

Accessori Accessories

Tech

Funzioni - Features

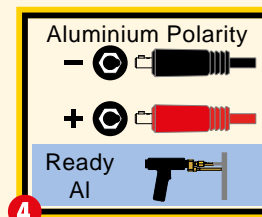
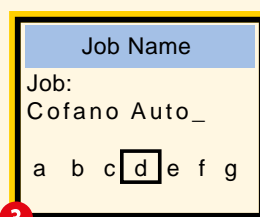
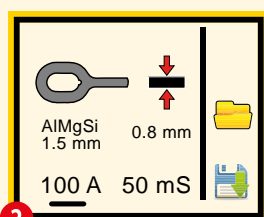
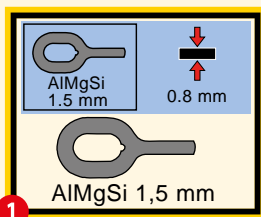

1 FUNZIONAMENTO AUTOMATICO

la corrente e il tempo di saldatura si regolano in modo **SINERGICO** a seconda della rondella o del perno da saldare e dello spessore di lavoro.

2 FUNZIONAMENTO MANUALE

è possibile regolare in modo **fine** la corrente e il tempo di saldatura a partire dal programma automatico precedentemente scelto.

3 SALVATAGGIO PROGRAMMI PERSONALIZZATI

consente di ritrovare facilmente i parametri ottimali per le applicazioni ricorrenti.

4 INDICAZIONE POLARITÀ

indicazione della corretta polarità di collegamento della **pistola PA1** in base al materiale di lavoro.

1 AUTOMATIC OPERATION

Current and welding time are set in **SYNERGIC** mode according to the pulling ring or stud to be welded and the material thickness.

2 MANUAL OPERATION

It is possible to **fine-tune** current and welding time starting from the previously selected automatic program.

3 SAVING CUSTOMIZED PROGRAMS

allows you to easily find the optimal parameters for recurring applications.

4 POLARITY INDICATION

Information of the correct connection polarity of the **PA1 gun** according to the material.

Optionals

010889
Carrello CR28
CR28 Trolley



NEW

272791 Pull ARC Basic KIT
pag. 97



SW 15 ALU LAB

STUD WELDER INVERTER

MODEL 2021



Autoriparazioni
Automotive

Carpenteria leggera
Light carpentry

ALLUMINIO
ALUMINIUM

ACCIAIO
STEEL

- Saldatrice di perni attraverso la scarica di condensatori
- Saldatura di perni su alluminio od acciaio
- Il dispositivo salda perni che permettono di eliminare le ammaccature e gli urti (pannelli della porta, cofano, ecc.)
- Facile e veloce da usare non richiede gas

- Stud welder through capacitor discharge
- Stud welding on aluminum or steel
- The device welds pins that allow to eliminate the dents and bumps (door panels, hood, etc.)
- Quick and easy to use, it does not require gas



*Accessori in dotazione

*Supplied accessories

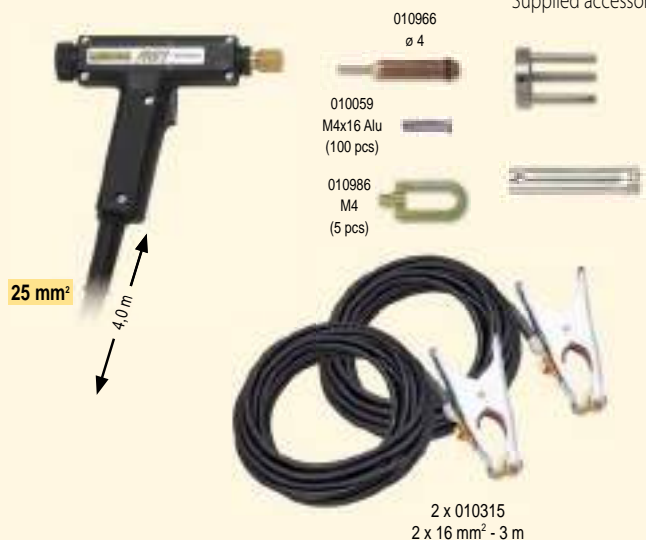

SW 15 Alu è lo studder DECA ad energia immagazzinata (SCARICA CAPACITIVA), idoneo per saldatura di perni d'acciaio e di alluminio. Può essere impiegato in carrozzeria e in altri ambiti in cui sia necessario saldare perni prigionieri.

SW 15 Alu is the DECA stored energy studder (CAPACITIVE DISCHARGE), suitable for welding steel and aluminum STUDS. The DECA solution for repairing aluminum car bodies. It can be used in bodywork and for other applications where stud bolts need to be welded.



MADE IN SAN MARINO		SW 15 ALU LAB	
Campo di regolazione - Range of output min-MAX V (volt) J (joule)		40V / 50J - 200V / 1500J	
Capacità - Capacity µF (Farad)		66000	
Tensione a vuoto - Open circuit voltage		3V	
Diametro perni - Stud size		3 - 8 mm	
Punti/minuti - Spots/minute	Ø 4 mm	20	
Punti/minuti - Spots/minute	Ø 8 mm	10	
Puntatura su - Stud welding on		Acciaio, inox, zincato, alluminio, rame - Steel, inox, galvanized steel, alu, copper	
Tensione di alimentazione - Input voltage		1 ph - 115/230V 50/60 Hz	
Ampere assorbiti - Max input amps		115V 8A	230V 4A
Potenza assorbita - Absorbed power: Max		0,4 kW	
Fusibile - Fuse		10A	6A
Generatore - Generator		+/- 15% (1,5 kW)	
Peso - Weight ≈		11,6 kg	
Dimensioni - Dimensions		405 x 190 x 400 mm	
Versione - Version			
*Generatore + accessori - *Power source + accessories		275900	
Accessori - Accessories p. 98			

Funzioni - Features

Risparmio energetico - Energy saving	•
Tabella parametri - Parameters chart	•
Spia alimentazione - Power indicator light	•
Spia anomalia - Malfunction indicator light	•
Morsetti previsti optional - Optional stud holder	Ø 3,0 - Ø 4,0 - Ø 5,0 - Ø 6,0 - Faston



Optionals

010889
Carrello CR28
CR28 Trolley



Accessori
pag. 98



MMA

TIG

MIG

PAC

MMA

TIG

MIG

PAC

CAR BODY
REPAIRAccessori
Accessories

Tech





DENT PULLER



SW 18 / 28 / 58 / 100 LAB

Elettrodi - Electrodes / Consumabili - Consumables

010896 (1 pc) Ø 16
Elettrodo per rondelle asolate
Electrode for oval washers



010990 (10 pcs)
Rondella asolata
Oval washers



010991 (10 pcs)
Rondella asolata piegata
Folded oval washers



010924 (1 pc) Ø 10
Elettrodo spot/filo ondulato
Spot/crimped wire electrode



010958 320 mm (10 pcs)
Filo ondulato
Crimped welding wire



010772 (20 pcs)
Rondelle a 3 punte 2 mm
3 Tips washers 2 mm



010765 ø8x16mm (1 pc) Ø 16
Elettrodo per rondelle
Electrode for washers



010753 ø8x16x1,5 (100 pcs)
Rondelle
Washers



010771 ø8x16mm (1 pc)
Mandrino rondelle
Mandrin washers



010767 M5 - M6 (1 pc) Ø 16
Elettrodo per viti M5-M6
Electrode for M5-M6 screws

010760 ø5x18mm (100 pcs) Ø 5
Perno autofilettante
Self-thread rivets



010759 ø5x25mm (100 pcs) Ø 5
Perno autofilettante
Self-thread rivets





010757 M5x18mm (100 pcs) M5
Perno filettato
Thread rivets



010987 (5 pcs) M5
Anello di tiro
Thread washers



010769 (5 pcs) Ø 10 300 mm
Elettrodo carbone caldalmiere
Sheet electrodes



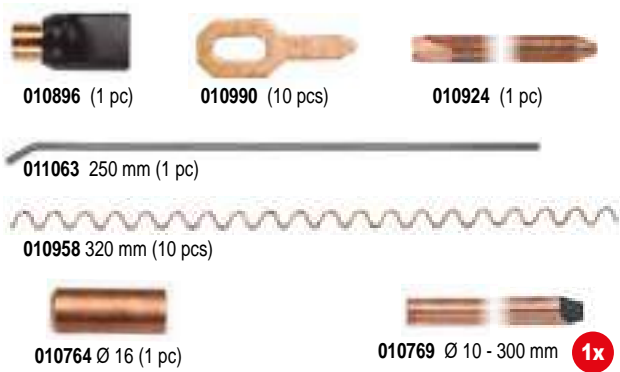

010093 KST1 Kit Tiro - Puller Kit

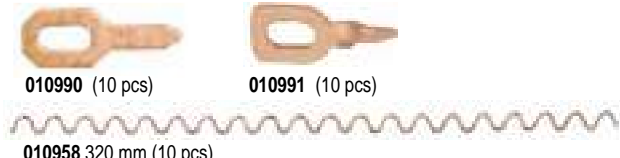

010896 (1 pc) 010990 (10 pcs) 010924 (1 pc)
011063 250 mm (1 pc)
010958 320 mm (10 pcs)
010764 Ø 16 (1 pc) 010769 Ø 10 - 300 mm 1x

010094 KST2 Kit Tiro consumabili - Puller Kit consumables



010990 (10 pcs) 010991 (10 pcs)
010958 320 mm (10 pcs)

010095 KST3 Kit Tiro rondelle - Puller Kit washers





010765 (1 pc) 010753 (100 pcs) 010771 (1 pc)

010092 KST5 Kit Tiro perni - Puller Kit rivets



010767 (1 pc) 010987 (5 pcs)
010759 (100 pcs) 010760 (100 pcs) 010757 (100 pcs)



010923 (1 pc)
Supporto magnetico filo ondulato
Magnetic support for crimped wire

010764 (1 pc) Ø 16
Elettrodo per schiacciature
Squashing electrode



010773 (1 pc) M14
Mandrino rondelle a 3 punte
Mandrin 3 tips washers



SW 18 / 28 / 58 / 100 LAB

010091 KST6 Kit Massa piastrino - Earth plate kit



010799 (1 pc)

010765 (1 pc)

010753 (100 pcs)

010076 (1 pc)

Massa - Mass

010799 (1 pc)

Ferma massa
Mass clamp



010076 (1 pc)

Piastrino di massa
Mass clamp



010917 (1 pc)

Massa a puntare
Mass clamp



Martelli - Hammers

010750 Kg 1 (1 pc)

Ø 10/16



M14

010738 Kg 1 (1 pc)

Ø 10/16



M14



010889
Carrello CR28
CR28 Trolley

Leve a tirare - Multihook level

010200 850 mm (1 pc)

KPSH1 KIT Traversa
KPSH1 KIT Levelling bar

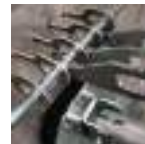
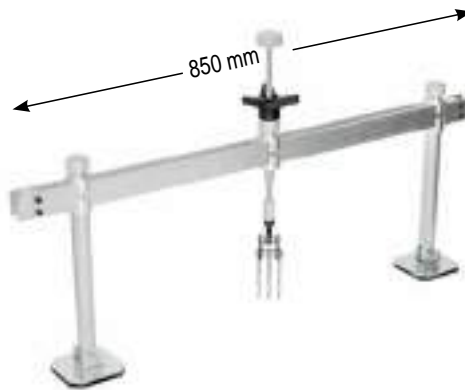

010312 700 mm (1 pc)

KPSL1 Leva a tirare
KPSL1 Multihook lever

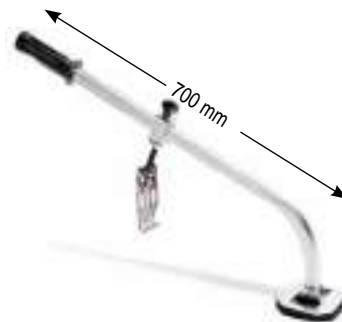

011044 250 mm (1 pc)

Traversa
Levelling bar



011063 250 mm (1 pc)

011064 500 mm (1 pc)

Perno di tiro
Traction rod

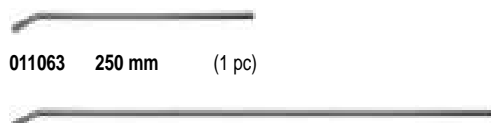

MMA

TIG

MIG

PAC

MMA

TIG

MIG

PAC

CAR BODY
REPAIR

Accessori
Accessories

Tech



Pull-ARC 250 LAB

Elettrodi - Electrodes / Consumabili - Consumables

Alluminio - Aluminium

Consumabili - Consumables

011048 AIMg3 1,0 mm (50 pcs)
011046 AIMg3 1,5 mm (50 pcs)



011049 AIMg3 1,0 mm (50 pcs)
011047 AIMg3 1,5 mm (50 pcs)









011052 AIMgSi 1,0 mm (50 pcs)
011050 AIMgSi 1,5 mm (50 pcs)

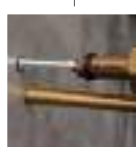

011053 AIMgSi 1,0 mm (50 pcs)
011051 AIMgSi 1,5 mm (50 pcs)



011054	AIMg3 ø 4	(50 pcs)		Ø 4	
Perno di tiro Traction nail					
010966	ø 4	(1 pc)			
Pinza Clamp					

010967	ø 5	(1 pc)			
Pinza Clamp					
011061	90 mm	(1 pc)			
Puntale di massa pistola Gun earth rod					
010059	AIMg3 M4x16	(100 pcs)		(M4)	
Perno filettato Thread rivets					
010974	AISI M5x20	(100 pcs)		(M5)	
Perno filettato Thread rivets					

011055 KDA1 Kit rondelle asolate AIMg3 Pulling rings kit AIMg3



011048 AIMg3 1,0 mm (50 pcs)
011046 AIMg3 1,5 mm (50 pcs)

011049 AIMg3 1,0 mm (50 pcs)
011047 AIMg3 1,5 mm (50 pcs)

011056 KDA2 Kit rondelle asolate AIMgSi Pulling rings kit AIMgSi



011052 AIMgSi 1,0 mm (50 pcs)
011050 AIMgSi 1,5 mm (50 pcs)

011053 AIMgSi 1,0 mm (50 pcs)
011051 AIMgSi 1,5 mm (50 pcs)

010081 KDA3 Kit perno di tiro - Traction rod kit



Acciaio - Steel

Consumabili - Consumables

010990 (10 pcs)
Rondella asolata
Oval washers



010991 (10 pcs)
Rondella asolata piegata
Folded oval washers



010757 M5x18 (100 pcs)
Perno filettato
Thread rivets







010759 ø 5x25 (100 pcs)
Perno autofilettante
Self-thread rivets



010760 ø 5x18 (100 pcs)
Perno autofilettante
Self-thread rivets



011059	(1 pc)		
Elettrodo per rondelle asolate Electrode for oval washers			
011060	114 mm (1 pc)		
Puntale di massa pistola Gun earth rod			
010986	(M4) (5 pcs)		
010987	(M5) (5 pcs)		
Anello di tiro Thread washers			



Pull-ARC 250 LAB



011045
Set martelli alluminio
Aluminium hammers kit

Leve a tirare - Multihook level

010200 850 mm (1 pc)
KPSH1 KIT Traversa
KPSH1 KIT Levelling bar

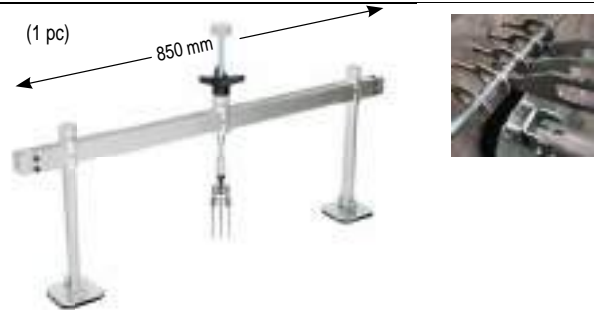

010312 700 mm (1 pc)
KPSL1 Leva a tirare
KPSL1 Multihook lever

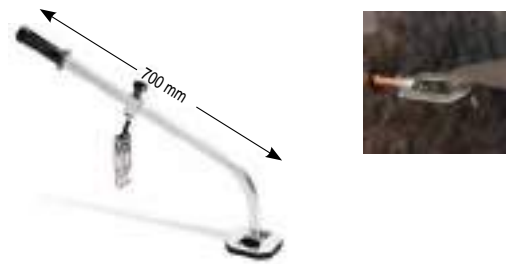

011044 250 mm (1 pc)
Traversa
Levelling bar



011063 250 mm (1 pc)

011064 500 mm (1 pc)
Perno di tiro
Traction rod



NEW

272791 Pull ARC 250 Basic Kit



272700
Pull Arc 250 LAB

010889
Carrello CR28
CR28 Trolley



011044 250 mm (1 pc)



011046 AIMg₃ 1,5 mm (50 pcs)



011047 AIMg₃ 1,5 mm (50 pcs)



011050 AIMgSi 1,5 mm (50 pcs)



011051 AIMgSi 1,5 mm (50 pcs)



010966 ø 4 (1 pc)



011054 AIMg₃ ø 4 (50 pcs)

NOT CONTRACTUAL



MMA

TIG

MIG

PAC

MMA

TIG

MIG

PAC

CAR BODY REPAIR

Accessori Accessories

Tech



STUD WELDER



STUD SW 15 Alu LAB

Pinze - Clamps

010965	ø 3	(1 pc)	
Pinza Clamp			
010966	ø 4	(1 pc)	
Pinza Clamp			
010967	ø 5	(1 pc)	
Pinza Clamp			
010968	ø 6	(1 pc)	
Pinza Clamp			
010970	ø 6,3	(1 pc)	
Pinza Faston Clamp Faston			



010939 Kit Alu

010965 ø 3 (1 pc)	010966 ø 4 (1 pc)
010967 ø 5 (1 pc)	010970 ø 6,3 (1 pc)
010979 6,3x0,8 (100 pcs)	010059 M4x16 (100 pcs)
010974 M5x20 (100 pcs)	010986 M4 (5 pcs)
	010987 M5 (5 pcs)

Alluminio - Aluminium

Consumabili - Consumables

010979 AIMg3 M6,3x0,8 (100 pcs)	
Faston	
010059 AIMg3 M4x16 (100 pcs)	
Perno filettato Thread rivets	
010974 AISi M5x20 (100 pcs)	
Perno filettato Thread rivets	

Acciaio - Steel

Consumabili - Consumables

010983 6,3x0,8 (100 pcs)	
Faston	
010980 M4x12 (100 pcs)	
Perno filettato Thread rivets	
010989 M5x16 (100 pcs)	
Perno filettato Thread rivets	
010975 M6x20 (100 pcs)	
Perno filettato Thread rivets	

010940 Kit Fe

010966 ø 4 (1 pc)	010968 ø 6 (1 pc)
010967 ø 5 (1 pc)	010970 ø 6,3 (1 pc)
010983 6,3x0,8 (100 pcs)	010980 M4x12 (100 pcs)
010989 M5x16 (100 pcs)	010975 M6x20 (100 pcs)
010988 M6 (5 pcs)	010984 M4x12 (100 pcs)

Inox

Consumabili - Consumables

010984 M4x12 (100 pcs)	
Perno filettato Thread rivets	



STUD SW 15 Alu LAB

011213 Kit pinze - Clamps kit

010965 \varnothing 3 (1 pc)



010968 \varnothing 6 (1 pc)



010967 \varnothing 5 (1 pc)



010970 \varnothing 6,3 (1 pc)



010986 **M4** (5 pcs)



010987 **M5** (5 pcs)



010988 **M6** (5 pcs)



Anello di tiro
Thread washers



0110079 Kit tiro - Traction kit

010966 \varnothing 4 (1 pc)



010059 M4x16 (100 pcs)



010986 M4 (5 pcs)



010980 M4x12 (100 pcs)



011063 250 mm (1 pc)



Leve a tirare - Multihook level

010200 850 mm (1 pc)
KPSH1 KIT Traversa
KPSH1 KIT Levelling bar

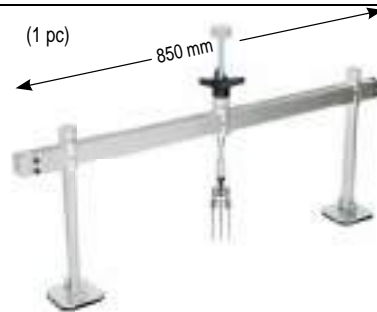

010312 700 mm (1 pc)
KPSL1 Leva a tirare
KPSL1 Multihook lever

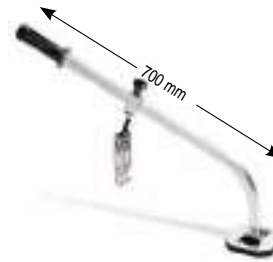

011044 250 mm (1 pc)
Traversa
Levelling bar



011063 250 mm (1 pc)



011064 500 mm (1 pc)

Perno di tiro
Traction rod



011045
Set martelli alluminio
Aluminium hammers kit



010889
Carrello CR28
CR28 Trolley



MMA

TIG

MIG

PAC

MMA

TIG

MIG

PAC

CAR BODY
REPAIR

Accessori
Accessories

Tech



Kit Bracci - Kit Arms SW 100 LAB

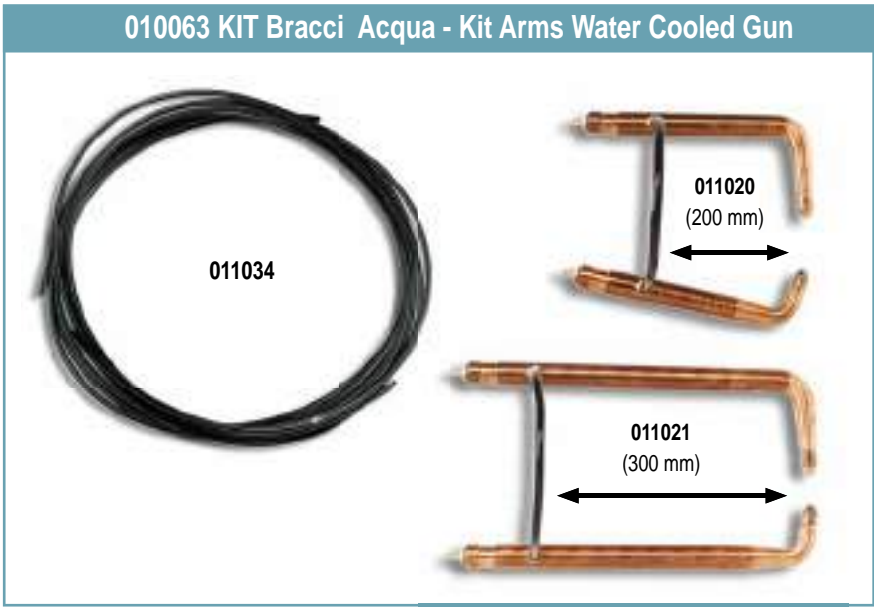
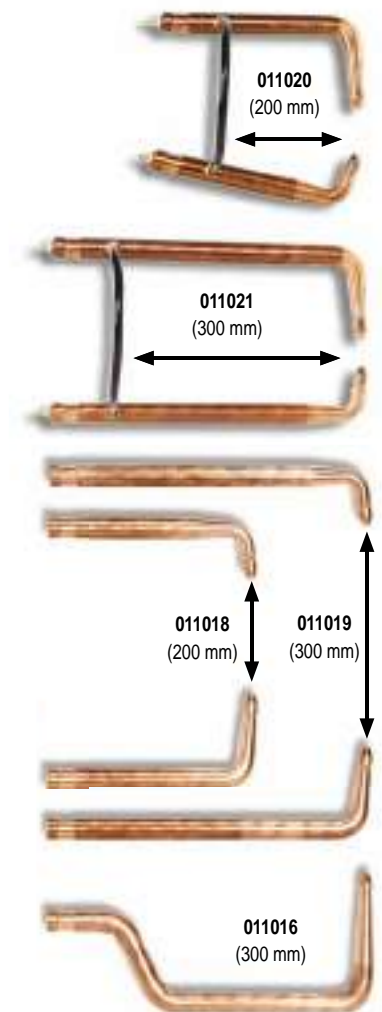

010639
Impianto raffreddamento WU18
WU18 Water cooling unit

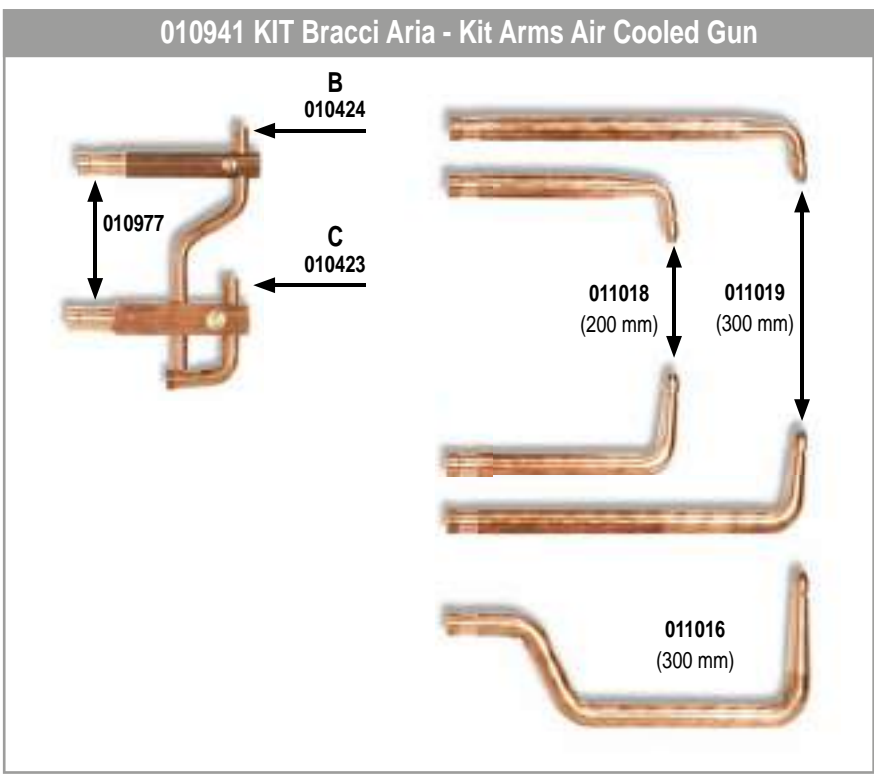
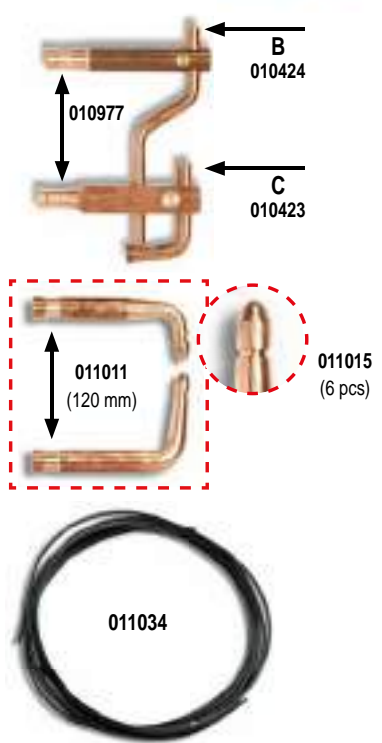

Accessori Accessories



MMA

TIG

MIG

PAC

MMA

TIG

MIG

PAC

CAR BODY
REPAIR

Accessori
Accessories

Tech



019001 Blister Displayer Concept
100 x 50 x 201,5 cm



019004 Displayer Concept
66 x 47 x 102 cm
3 ripiani - 3 shelves

Punto Vendita / POP



Presentare il prodotto

Questi prodotti sono in confezione da espositore

Exposing the product

These products are in display pack

NEW 04/2021

Maschere per saldatura con filtro auto-oscurante Welding helmets with Auto Darkening Filter

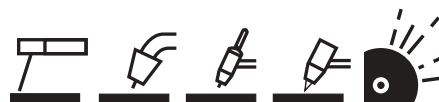

DIN 5-9 / 9-13

WM 40TC



- Livello di sensibilità regolabile per un migliore rilevamento dell'arco
- Sensori: 4
- Delay Time regolabile
- Schermo di grandi dimensioni
- Adatta per: MMA, MIG, TIG, PAC, GRIND



- Adjustable sensitivity level for a better arc detection
- Sensors: 4
- Adjustable Delay Time
- Extra large screen
- Suitable for: MMA, MIG, TIG, PAC, GRIND

DIN 5-9 / 9-13

WM 35TC



- Livello di sensibilità regolabile per un migliore rilevamento dell'arco
- Sensori: 4
- Delay Time regolabile
- Schermo di grandi dimensioni
- Adatta per: MMA, MIG, TIG, PAC, GRIND



- Adjustable sensitivity level for a better arc detection
- Sensors: 4
- Adjustable Delay Time
- Extra large screen
- Suitable for: MMA, MIG, TIG, PAC, GRIND

DIN 9-13

WM 31TC



- Livello di sensibilità regolabile per un migliore rilevamento dell'arco
- Sensori: 2
- Delay Time regolabile
- Schermo di grandi dimensioni
- Adatta per: MMA, MIG, TIG, GRIND



- Adjustable sensitivity level for a better arc detection
- Sensors: 2
- Adjustable Delay Time
- Extra large screen
- Suitable for: MMA, MIG, TIG, GRIND



DIN 9-13

WM 27

MMA

MIG

TIG

- Livello di sensibilità regolabile per un migliore rilevamento dell'arco
- Sensori: 2
- Delay Time regolabile
- Adatta per: MMA, MIG, TIG

- Adjustable sensitivity level for a better arc detection.
- Sensors: 2
- Adjustable Delay Time
- Suitable for: MMA, MIG, TIG

+1 GLASS EXTRA!



DIN 11

WM 24

MMA

MIG

TIG

- Sensori: 2
- Adatta per: MMA, MIG, TIG (> 30Amp)

- Sensors: 2
- Suitable for: MMA, MIG, TIG (> 30Amp)

+1 GLASS EXTRA!



	WM 24	WM 27	WM 31TC	WM 35TC	WM 40TC
Campo di visuale - Viewing Area	90 x 34 mm	93 x 43 mm	93 x 43 mm	100 x 60 mm	100 x 83 mm
Colori reali - True color			•	•	•
Sensori d'arco - Arc Sensor	2	2	2	4	4
Posizione chiara: grado di protezione - Light State: Shade	DIN 3	DIN 4	DIN 4	DIN 4	DIN 4
Posizione scura: grado di protezione - Dark State: Shade	DIN 11	DIN 9-13	DIN 9-13	DIN 5-9 / 9-13	DIN 5-9 / 9-13
Accensione / spegnimento automatico Automatic Power On / Off	•	•	•	•	•
Alimentazione - Power Supply	☀ + 🔋	☀ + 🔋	☀ + 🔋 (CR2450)	☀ + 🔋 (CR2450)	☀ + 🔋 (CR2450)
Tempo di commutazione da Chiaro a Scuro (Delay time da Scuro a Chiaro) Switching Time from Light to Dark (Delay time from Dark to Light)	5/10,000s (0.2s)	3/10,000s (0.1 ~ 0.8s)	3 / 10,000s (0.1 ~ 0.8s)	1/10,000s (0.1 ~ 0.8s)	1/10,000s (0.1 ~ 0.8s)
Classe ottica - Optical class	1/1/1/3	1/1/1/2	1/1/1/1	1/1/1/1	1/1/1/1
Smerigliatura - Grind			•	•	•
Taglio - Cut				•	•
Temperatura di esercizio - Operating Temp.	-5°C ~ +55°C	-5°C ~ +55°C	-5°C ~ +55°C	-5°C ~ +55°C	-5°C ~ +55°C
Peso - Weight	460 gr	500 gr	500 gr	556 gr	584 gr
Codice - Code	010402	010404	010408	010412	010414
Optionals					
Protezione filtro esterna - Front cover filter (2 pcs)	010381 118 x 95 x 1 mm	010365 110 x 90 x 1 mm	010365 110 x 90 x 1 mm	010382 138 x 122 x 1 mm	010382 138 x 122 x 1 mm

🔋: Batteria non sostituibile - No replaceable battery

MMA

TIG

MIG

PAC

MMA

TIG

MIG

PAC

CAR BODY
REPAIR

Accessori
Accessories

Tech

Maschere per saldatura con filtro auto-oscurante

Welding helmets with Auto Darkening Filter

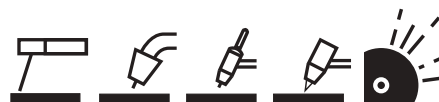

WM 23

- Valore di filtro chiaro: 3
- Valore di filtro scuro: fisso 11
- Sensori: 2
- Adatta per: MMA, MIG, TIG (> 20Amp).
- Single light shade of 3
- Single dark shade of 11
- Sensors: 2
- Suitable to: MMA, MIG, TIG (> 20Amp).



WM 31

- Valore di filtro chiaro: 4
- Valore di filtro scuro: regolabile da 9 a 13
- Livello di sensibilità regolabile per un migliore rilevamento dell'arco.
- Sensori: 2
- Delay Time regolabile
- Adatta per: MMA, MIG, TIG, GRIND.
- Single light shade of 4
- Selectable dark shade from shade 9 to 13
- Adjustable sensitivity level for a better arc detection.
- Sensors: 2
- Adjustable Delay Time
- Suitable to: MMA, MIG, TIG, GRIND.



WM 35

- Valore di filtro chiaro: 4
- Valore di filtro scuro: regolabile da 5-9 a 9-13
- Livello di sensibilità regolabile per un migliore rilevamento dell'arco.
- Sensori: 4
- Delay Time regolabile
- Schermo di grandi dimensioni
- Adatta per: MMA, MIG, TIG, PAC, GRIND.
- Single light shade of 4
- Selectable dark shade from shade 5-9 to 9-13
- Adjustable sensitivity level for a better arc detection.
- Sensors: 4
- Adjustable Delay Time
- Extra large screen
- Suitable to: MMA, MIG, TIG, PAC, GRIND.

	WM 23	WM 31	WM 35
Campo di visuale - Viewing Area	90 x 34 mm	93 x 43 mm	100 x 60 mm
Dimensione cartuccia filtro - Cartridge Size	110 x 90 x 9 mm	110 x 90 x 9 mm	133 x 114 x 10 mm
Sensori d'arco - Arc Sensor	2	2	4
Posizione chiara: grado di protezione - Light State: Shade	DIN 3	DIN 4	DIN 4
Posizione scura: grado di protezione - Dark State: Shade	DIN 11	DIN 9-13	DIN 5-9 / 9-13
Accensione / spegnimento - Power On/Off	On/Off automatico - Fully automatic	On/Off automatico - Fully automatic	On/Off automatico - Fully automatic
Protezione UV/IR - UV/IR Protection	Superiore al grado di protezione DIN 16 in tutte le condizioni - Up To Shade DIN 16 at all time		
Alimentazione - Power Supply	1 cella solare. Senza batterie da sostituire 1 solar cell. No battery replaceable	1 cella solare. 1 batteria sostituibile 1 solar cell. 1 battery replaceable	1 cella solare. 2 batterie sostituibili 1 solar cell. 2 batteries replaceable
Tempo di commutazione - Switching Time	4/10,000s. da Chiaro a Scuro 0.25 ~ 0.45s da Scuro a Chiaro 4/10,000s. from Light to Dark 0.25 ~ 0.45s from Dark to Light	3/10,000s. da Chiaro a Scuro 0.1 ~ 0.8s da Scuro a Chiaro 3/10,000s. from Light to Dark 0.1 ~ 0.8s from Dark to Light	1/10,000s. da Chiaro a Scuro 0.1 ~ 0.8s da Scuro a Chiaro 1/10,000s. from Light to Dark 0.1 ~ 0.8s from Dark to Light
Temperatura di esercizio - Operating Temp.	-5°C ~ +55°C	-5°C ~ +55°C	-5°C ~ +55°C
Classe ottica - Optical class	1/1/1/3	1/1/1/1	1/1/1/1
Resistenza agli urti - Impact resistance	F		
Temperatura di stoccaggio - Storing Temp.	-20°C ~ +70°C	-20°C ~ +70°C	-20°C ~ +70°C
Modello filtro - Filter model	WM23	WM31	WM35
Peso - Weight	450 gr	510 gr	535 gr
Codice - Code	010362	010364	010377
Optionals			
Protezione filtro esterna - Front cover filter (2 pcs)	010381 118 x 95 x 1 mm (curvo - curved)	010365 110 x 90 x 1 mm	010382 138 x 122 x 1 mm (curvo - curved)

Maschere per saldatura con filtro inattinico

Welding masks with adiacinic filter



WM 18

- Valore di filtro scuro: fisso 11
- Adatta per: MMA, MIG, TIG (> 20Amp)
- Resistenza agli urti EN 175: SW
- Single dark shade of 11
- Suitable to: MMA, MIG, TIG (> 20Amp)
- Impact resistance EN 175: SW



WM 19

Schermo in fibra. Senza vetri

- Dimensioni vetro 75 x 98 mm.
- Adatta per: MMA, MIG, TIG (> 20Amp)
- Resistenza agli urti EN 175: SW

Pressed fiber handshield. Without glasses

- Glass dimensions 75 x 98 mm.
- Suitable to: MMA, MIG, TIG (> 20Amp)
- Impact resistance EN 175: SW



WM 20

- Valore di filtro scuro: fisso 11
- Adatta per: MMA, MIG, TIG (> 20Amp)
- Resistenza agli urti EN 175: SW
- Single dark shade of 11
- Suitable to: MMA, MIG, TIG (> 20Amp)
- Impact resistance EN 175: SW

	WM 18	WM 19	WM 20
Campo di visuale - Viewing Area	75 x 98 mm	75 x 98 mm	75 x 98 mm
Posizione scura: grado di protezione - Dark State: Shade	DIN 11	-	DIN 11
Protezione UV/IR - UV/IR Protection	Superiore al grado di protezione DIN 16 in tutte le condizioni - Up To Shade DIN 16 at all time		
Temperatura di esercizio - Operating Temp.	-5°C ~ +55°C	-5°C ~ +55°C	-5°C ~ +55°C
Temperatura di stoccaggio - Storing Temp.	-20°C ~ +70°C	-20°C ~ +70°C	-20°C ~ +70°C
Peso - Weight	380 gr	240 gr	430 gr
Codice - Code	010319	010336	010320
Accessori - Accessoires			
Vetro trasparente - Transparent glass (4 pcs)	010338 75 x 98 x 2 mm	010338 75 x 98 x 2 mm	010338 75 x 98 x 2 mm
Vetro inattinico - Adiacinic glass DIN 11 (2 pcs)	010339 75 x 98 x 3 mm	010339 75 x 98 x 3 mm	010339 75 x 98 x 3 mm

Abbigliamento di protezione

Protective clothing



Cuffia cotone ignifugo
Fireproof cotton cap
010888

Chiusura regolabile in velcro.
Adjustable velcro strap.



Grembiule in crosta 60x90
Crust leather apron 60x90
010847 taglia - size L

In crosta con doppie cuciture in kevlar, taschino, lacci in nylon con ganci automatici.
Double kevlar seams, pocket, nylon laces with automatic hooks.



Guanti saldatura in crosta
Crust leather welding gloves
010963 taglia - size 10

In crosta con cuciture in kevlar, foderato in cotone, rinforzi sul palmo e pollice.
Kevlar seams, internal cotton padding, palm and thumb fold reinforcement.



● **Elettrodi rutili per acciai non legati e basso legati.**

Innesco facile. Ottimo aspetto del cordone e facile rimozione della scoria.

Settori applicativi











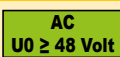

Costruzioni metalliche in genere. Carpenteria leggera. Riparazioni.

● **Rutile electrodes for unalloyed and low alloyed steels.**

Easy initiation. Excellent bead appearance and easy slag removal.

Main application

General structural work. Light carpentry. Repairing.

Codice Code	Diametro Diameter	Lunghezza Length	Quantità Quantity	Intensità corrente Current intensity	Classificazione Classification	Posizioni di saldatura Welding position	Tipo di corrente Type of current
Elettrodo rutilico Rutile electrode					AWS A5.1 E6013 EN 499 E 42 0 RR 12		 DC  AC U0 ≥ 48 Volt
010220 	1,6 mm	300 mm	40	20 - 40 A			
010224 	1,6 mm	300 mm	100	20 - 40 A			
010221 	2,0 mm	300 mm	40	40 - 60 A			
010225 	2,0 mm	300 mm	80	40 - 60 A			
010112	2,0 mm	300 mm	400	40 - 60 A			
010222 	2,5 mm	300 mm	30	60 - 90 A			
010125 	2,5 mm	300 mm	55	60 - 90 A			
010113	2,5 mm	300 mm	275	60 - 90 A			
010223 	3,2 mm	350 mm	16	90 - 120 A			
010126 	3,2 mm	350 mm	30	90 - 120 A			
010114	3,2 mm	350 mm	145	90 - 120 A			
011043 	4,0 mm	350 mm	95	120 - 180 A			

● **Elettrodi basici a basso contenuto di idrogeno.**

Fusione senza spruzzi. Innesco abbastanza facile. Deposito regolare. Facile da pulire.

Settori applicativi







Elettrodi per applicazioni dove sono richieste ottime proprietà meccaniche.

● **Basic electrodes (low hydrogen).**

Melting without spatter. Quite easy initiation. Regular cords. Easy cleaning.

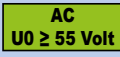
Main application

Electrodes for applications requiring high mechanical strength.

Elettrodo basico Basic electrode	Diametro Diameter	Lunghezza Length	Quantità Quantity	Intensità corrente Current intensity	Classificazione Classification	Posizioni di saldatura Welding position	Tipo di corrente Type of current
Elettrodo basico Basic electrode					AWS A5.1: E 7018-1 ISO 2560-A-E463B42H5		 DC  AC U0 ≥ 55 Volt
010127 	2,5 mm	350 mm	30	70 - 90 A			
011040 	2,5 mm	350 mm	230	70 - 90 A			
011042 	3,2 mm	350 mm	30	110 - 140 A			
011041 	3,2 mm	350 mm	140	110 - 140 A			

● **Elettrodi rutili per acciai inox (19Cr-10Ni).**

Fusione senza spruzzi. Deposito regolare. Facile da pulire.

Settori applicativi







Utilizzato per la saldatura dell'acciaio inox tipo AISI 304 ed in tutte le costruzioni dove è richiesta una buona resistenza alla corrosione ed ossidazione.

● **Rutile electrodes for stainless steel (19Cr-10Ni).**

Melting without spatter. Regular cords. Easy cleaning.

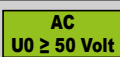
Main application

Used for welding of stainless steel AISI 304 and in all constructions which require a good resistance to corrosion and oxidation.

Elettrodo acciaio inox Stainless steel electrode	Diametro Diameter	Lunghezza Length	Quantità Quantity	Intensità corrente Current intensity	Classificazione Classification	Posizioni di saldatura Welding position	Tipo di corrente Type of current
Elettrodo acciaio inox Stainless steel electrode					AWS A5.4 E 308L-17 EN 1600 E 19 9 LR 32		 DC  AC U0 ≥ 50 Volt
010128 	2,0 mm	300 mm	40	35 - 50 A			
011039 	2,0 mm	300 mm	178	35 - 50 A			
010129 	2,5 mm	300 mm	30	50 - 80 A			
010115 	2,5 mm	300 mm	102	50 - 80 A			

● **Elettrodo con rivestimento basico-grafitico per saldare ghisa senza o con basso preriscaldamento (300°C).**

Per riparazioni di pezzi in ghisa o per unire pezzi in acciaio rame o nickel alle fusioni. Innesco facile. Superficie del cordone liscia.

Settori applicativi





Riparazioni.

● **Basic-graphite coated MMA electrode with a pure nickel core wire for welding cast iron without or with low preheating (max. +300°C).**

For repair welding of cracked cast iron parts or joining components made of steel, copper or nickel materials to casting. Easy arc striking and restriking. Smooth bead surface.

Main application

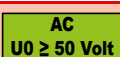
Repairing.

Elettrodo ghisa Cast iron electrode	Diametro Diameter	Lunghezza Length	Quantità Quantity	Intensità corrente Current intensity	Classificazione Classification	Posizioni di saldatura Welding position	Tipo di corrente Type of current
Elettrodo ghisa Cast iron electrode					AWS A5.15 Eni-CI EN 1071 E C Ni-CI 1		 DC  AC U0 ≥ 50 Volt
010131 	2,5 mm	300 mm	6	60 - 90 A			
010130 	2,5 mm	300 mm	16	60 - 90 A			



● Acciaio

Di impiego generale, indicato per l'unione di acciai al carbonio comuni.
Da impiegarsi nella carpenteria in genere, serbatoi, carrozzerie, ecc.

● Steel

Suitable for the joint of unalloyed carbon steels.
To be used for steel structures in general, carbody repair, tanks, etc.

Codice Code	Diametro Diameter	Bobina Spool	Quantità Quantity	Intensità corrente Current intensity	Gas di protezione Shielding gas	Classificazione Classification	Tipo di corrente Type of current
Acciaio Steel					Argon/CO ₂ CO ₂	AWS A5.18: ER 70S-6 EN ISO 14341-A: G 42 2 M G3Si1	
010871	ø 0,6	ø 100 mm	0,7 kg	30 - 100 A			
010801	ø 0,6	ø 200 mm	5,0 kg	30 - 100 A			
010872	ø 0,8	ø 100 mm	0,7 kg	60 - 200 A			
010805	ø 0,8	ø 200 mm	5,0 kg	60 - 200 A			
010846	ø 1,0	ø 200 mm	5,0 kg	65 - 220 A			

● Alluminio/Magnesio 5%

Filo pieno in alluminio indicato per la saldatura di leghe contenenti fino al 5% di magnesio. Trova impiego nella costruzione di strutture per la cantieristica navale, nel ferroviario, nel settore automobilistico e nella costruzione di serbatoi.

● Aluminum/Magnesium 5%

Solid aluminium wire suitable for welding alloys containing up to 5% magnesium, used in the construction of structures in shipbuilding, railways, automotive and tank sector.

Alluminio/Magnesio 5% Aluminium/Magnesium 5%	Diametro	Bobina	Quantità	Intensità corrente	Gas di protezione	Classificazione	Tipo di corrente
					Argon	AWS A5.10: ER 5356 EN ISO 18273: S Al 5356 (AlMg5Cr(A))	
010881	ø 0,8	ø 100 mm	0,4 kg	60 - 170 A			
010882	ø 1,0	ø 100 mm	0,4 kg	90 - 210 A			
010876	ø 1,0	ø 200 mm	2,0 kg	90 - 210 A			

● Alluminio/Silicio 5%

Filo pieno in alluminio al 5% di Si. Indicato per la saldatura di leghe Al-Si 2-7%, e leghe Al-Mg-Si. Trova impiego nella costruzione di strutture per impieghi architettonici, cassoni per autotreni, serbatoi e per la riparazione di fusioni.

● Aluminum/Silicon 5%

Solid aluminium wire with 5% Si. Suitable for welding Al Si 2-7% alloys, and Al-Mg-Si alloys. It is used in the construction of structures for architectonic uses, trailer-truck bodies, tanks and casting repair.

Alluminio/Silicio 5% Aluminium/Silicon 5%	Diametro	Bobina	Quantità	Intensità corrente	Gas di protezione	Classificazione	Tipo di corrente
					Argon	AWS A5.10: ER 4043 EN ISO 18273: S Al 4043 (AlSi5(A))	
010844	ø 1,0	ø 100 mm	0,5 kg	90 - 210 A			
010860	ø 1,0	ø 200 mm	2,0 kg	90 - 210 A			

● Acciaio inox

Filo pieno idoneo alla saldatura di acciai inossidabili del tipo AISI 301, 304 e 304L. Ottima resistenza alla corrosione.

● Stainless Steel

Solid wire suitable for welding stainless steels AISI 301, 304 and 304L type. Excellent resistance to corrosion.

Acciaio inox Stainless steel	Diametro	Bobina	Quantità	Intensità corrente	Gas di protezione	Classificazione	Tipo di corrente
					Argon Argon/O ₂	AWS A5.9: ER 308L Si EN ISO 14343-A: G 19 9 L Si	
010892	ø 0,8	ø 100 mm	0,7 kg	65 - 220 A			

● Animato

Filo Animato autoprotetto multiposizionale ideale per saldature single-pass su acciaio al carbonio.

● Self-shielded

All positional self-shielded wire, ideal single-pass welding of carbon steel.

Animato Self-shielded	Diametro	Bobina	Quantità	Intensità corrente	Gas di protezione	Classificazione	Tipo di corrente
					xx	AWS A5.20: E71T-GS	
010827	ø 0,6	ø 100 mm	0,7 kg	20 - 80 A			
010818	ø 0,9	ø 100 mm	0,7 kg	40 - 100 A			
010816	ø 0,9	ø 200 mm	2,0 kg	40 - 100 A			

● Rame/Silicio 3%

Filo pieno idoneo alla saldatura di leghe rame-silicio o rame-zinco. Particolarmente indicato per la saldobrasatura delle lamiere zincate nel settore carrozzeria.

● Copper/Silicon 3%

Solid wire suitable for welding of copper-zinc or copper-silicon. Particularly suitable for brazing of galvanized sheet metal in the bodywork.

Rame/Silicio 3% Copper/Silicon 3%	Diametro	Bobina	Quantità	Intensità corrente	Gas di protezione	Classificazione	Tipo di corrente
					Argon	AWS A5.7: ER CuSi-A EN ISO 14640: S CuSi3Mn1 - S Cu6560	
010845	ø 0,8	ø 200 mm	2,0 kg	65 - 220 A			
010848	ø 0,8	ø 200 mm	5,0 kg	65 - 220 A			

Modello Model	A						B	C	D	E
	Kit di saldatura MMA - MMA Welding Kit						Porta elettrodi Electrode holder	Morsetto massa Earth clamp	Cavo Cable	Attacchi Socket
	DS10 000200	DS16 000201	DS20 000217	DS35 000205	DS50 000207	DS60 000209				
SIL 208	-	-	-	-	-	-	010301	010310	-	-
SIL 313	●	-	-	-	-	-	010301	010310	010353	010385
SIL 415	●	-	-	-	-	-	010301	010310	010353	010385
SIL 417	-	●	-	-	-	-	010303	010311	010357	010385
SIL 417 GEN	-	●	-	-	-	-	010303	010311	010357	010385
i-ARC 215	-	●	-	-	-	-	010303	010311	010358	010385
i-ARC 217	-	●	-	-	-	-	010303	010311	010358	010385
i-ARC 318	-	-	●	-	-	-	010303	010311	010358	010385
i-ARC 320	-	-	●	-	-	-	010303	010311	010358	010385
i-ARC 319C LAB	-	-	●	-	-	-	010303	010311	010358	010385
i-ARC 525 LAB				●	-	-	010307	010315	010359	010386
Globus mini	-	-	-	-	-	-	010301	010310	-	-
Globus 3.0	-	-	-	-	-	-	010301	010310	-	-
Globus 4.0	-	-	-	-	-	-	010301	010310	-	-
Globus 4.2	-	-	-	-	-	-	010301	010310	-	-
Globus 5.0 D	-	●	-	-	-	-	010303	010311	010357	010385
T-Arc 525 LAB	-	-	●	-	-	-	010303	010311	010358	010385
T-Arc 527 LAB	-	-	●	-	-	-	010303	010311	010358	010385
T-Arc 529 LAB	-	-	●	-	-	-	010303	010311	010358	010385
T-Arc 530 LAB	-	-	-	●	-	-	010307	010315	010359	010386
T-Arc 845 LAB	-	-	-	-	●	-	010304	010317	010360	010387
P-Arc 525 LAB	-	-	●	-	-	-	010303	010311	010358	010385
P-Arc 526 LAB	-	-	-	●	-	-	010307	010315	010359	010386
P-Arc 735 LAB	-	-	-	●	-	-	010307	010315	010359	010386
P-Arc 840 LAB	-	-	-	-	●	-	010304	010317	010360	010387
P-Arc 846 LAB	-	-	-	-	●	-	010304	010317	010360	010387
E-Arc 840 LAB	-	-	-	-	●	-	010304	010315	010360	010387
E-Arc 860 LAB	-	-	-	-	-	●	010306	010317	010361	010387



A Welding Kit

B Pinze porta elettrodi
Electrode holders

DS10 160A
000200 3+2 m  25 mm²



DS16 180A
000201 3+2 m  25 mm²

DS20 200A
000217 3+2 m  25 mm²

DS35 350A
000205 3+3 m  50 mm²

DS50 500A
000207 3+3 m  70 mm²

DS60 600A
000209 3+3 m  70 mm²



(a) 010301 160A 200A@35% (1 pc) 
 (b) 010303 200A 200A@35% (1 pc) 
 (c) 010307 300A 300A@35% (1 pc)
 (c) 010304 400A 400A@35% (1 pc)
 (c) 010306 600A 600A@35% (1 pc)



C Morsetti di massa
Earth clamps

D Cavo
Cable

E Attacchi
Sockets

(a) 010310 160A (1 pc) 
 (b) 010311 200A 200A@35% (1 pc) 
 (c) 010315 350A 350A@35% (1 pc)
 (d) 010317 500A 500A@35% (1 pc)

010353 10 mm² (10m) (1 pc)
 010357 16 mm² (10m) (1 pc)
 010358 25 mm² (10m) (1 pc)
 010359 35 mm² (10m) (1 pc)
 010360 50 mm² (10m) (1 pc)
 010361 70 mm² (10m) (1 pc)

010385 25 mm² (2 pcs) 
 010386 50 mm² (2 pcs)
 010387 70 mm² (2 pcs)

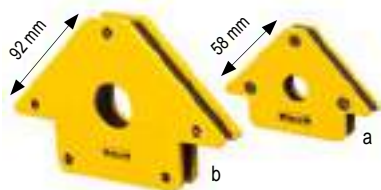

Posizionatore magnetico
Magnetic position holder

Spazzola
Brush

Martellina battiscoria
Hammer

(a) 010345 MPH 62 (1 pc) 
 (b) 010346 MPH 92 (1 pc) 

(a) 010342 (1 pc) 
 (b) 010343 (1 pc) 





010341 (1 pc) 

Torces TIG e dotazione - TIG torches and equipment

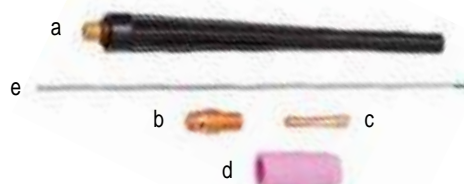

010614 TIG 110A Eco Valve 3 m  25 mm²
(SIL Series - i-ARC 2 Series, i-ARC 3 Series - SILTIG 415)



Cappuccio lungo - Long cap	Ugello - Nozzle
 (a) 010655 (3 pcs)	 (d) No.6 010656 (10 pcs)
Diffusore - Diffuser	Elettrodo - Electrode
 (b) ø 1,6 010657 (3 pcs)	 (e) ø 1,6 010694 (10 pcs)
Pinze serra elettrodo - Electrode holder	(Vedi tabella - See table pag. 112)
 (c) ø 1,6 010658 (3 pcs)	



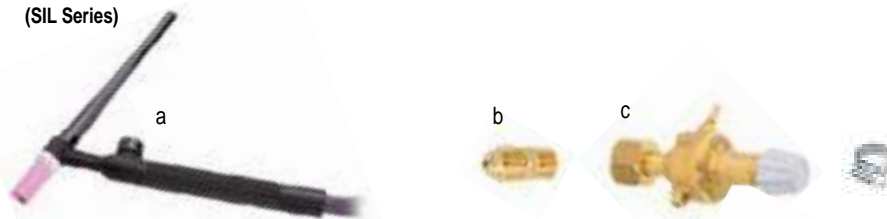

010061 KIT TIG TG9

TIG 110A Eco Valve 3 m  25 mm² (010614) (a)
Adattatore - Adapter CO₂ → Ar (010571) (b)
Riduttore pressione - Pressure reducer (010499) (c)
(SIL Series)



010825 TIG 140A Valve 4 m  50 mm²
(Easy JOB 525 - JOB 635 - i-ARC 525 LAB)



Cappuccio lungo - Long cap	Ugello - Nozzle
 (a) 010369 (3 pcs)	 (d) No.6 010690 (10 pcs)
Diffusore - Diffuser	(d) No.8 010691 (10 pcs)
 (b) ø 1,6 010645 (3 pcs)	(d) No.10 010692 (10 pcs)
(b) ø 2,4 010643 (3 pcs)	Elettrodo - Electrode
(b) ø 3,2 010644 (3 pcs)	 (e) ø 1,6 010694 (10 pcs)
(b) ø 4,0 010660 (3 pcs)	(Vedi tabella - See table pag. 112)
Pinze serra elettrodo - Electrode holder	
 (c) ø 1,6 010633 (3 pcs)	
(c) ø 2,4 010635 (3 pcs)	
(c) ø 3,2 010636 (3 pcs)	
(c) ø 4,0 010661 (3 pcs)	

010068 KIT TIG TG17 140A Valve 4 m  50 mm² (010825) (a)
Adattatore torcia TIG - TIG torch adapter 25 mm² → 50 mm² (010820) (b)
(i-ARC 2 Series, i-ARC 3 Series, MIGA Series - JOB Series)





010375 TIG 140A "Tyco" 4 m 25 mm²
(MASTROTIG 218 AC - 216 AC/DC)

010380 TIG 140A "DIN5" 4 m 25 mm²
(i-TIG Series)



010811 TIG 180A "Tyco" 4 m 50 mm²
(MASTROTIG 327 AC/DC)

010812 TIG 180A "Tyco" 8 m 50 mm²
(MASTROTIG 327 AC/DC)

010230 TIG 180A "XLR" 4 m 50 mm²
(E-ARC Series)

010809 TIG 180A "XLR" 8 m 50 mm²
(E-ARC Series)



010813 TIG 320A "Tyco" "H2O" 4 m 50 mm²
(MASTROTIG 327 AC/DC)

010815 TIG 320A "Tyco" "H2O" 8 m 50 mm²
(MASTROTIG 327 AC/DC)



Cappuccio lungo - Long cap
■ (a) **010369** (3 pcs)

Diffusore - Diffuser
■ (b) \varnothing 1,6 **010645** (3 pcs)
(b) \varnothing 2,4 **010643** (3 pcs)
(b) \varnothing 3,2 **010644** (3 pcs)
(b) \varnothing 4,0 **010660** (3 pcs)

Pinze serra elettrodo - Electrode holder
■ (c) \varnothing 1,6 **010633** (3 pcs)
(c) \varnothing 2,4 **010635** (3 pcs)
(c) \varnothing 3,2 **010636** (3 pcs)
(c) \varnothing 4,0 **010661** (3 pcs)

Ugello - Nozzle
■ (d) No.6 **010690** (10 pcs)

(d) No.8 **010691** (10 pcs)
(d) No.10 **010692** (10 pcs)

Elettrodo - Electrode
■ (e) \varnothing 1,6 **010694** (10 pcs)

(Vedi tabella - See table pag. 112)

STARTER KIT per torçe - for torches:

TIG140 A valve, TIG 140A, TIG 180A, TIG 320A

■ **010072 KIT STARTER \varnothing 2,4 acciaio-steel**

Elettrodo - Electrode
1 pc \varnothing 2,4 WC20 (010696) (a)

Diffusore - Diffuser
1 pc \varnothing 2,4 (010643) (b)

Pinze serra elettrodo - Electrode holder
1 pc \varnothing 2,4 (010635) (c)

Ugello - Nozzle
1 pc No.6 (010690) (d)

■ **010083 KIT STARTER \varnothing 2,4 / 3,2 acciaio-steel, \varnothing 1,6 / 2,4 / 3,2 alluminio-aluminium**

Elettrodo - Electrode
1 pc \varnothing 1,6 WP alluminio/aluminium (010697) (a)

1 pc \varnothing 2,4 WP alluminio/aluminium (010699)

1 pc \varnothing 3,2 WP alluminio/aluminium (010700)

1 pc \varnothing 2,4 WC20 acciaio/steel (010696)

1 pc \varnothing 3,2 WC20 acciaio/steel (010668)

Diffusore - Diffuser
1 pc \varnothing 2,4 (010643) (b)

1 pc \varnothing 3,2 (010644)

Pinze serra elettrodo - Electrode holder
1 pc \varnothing 2,4 (010635) (c)

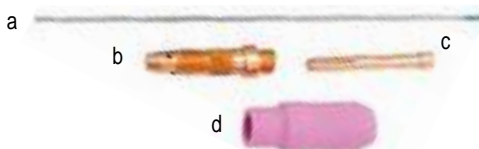

1 pc \varnothing 3,2 (010636)

Ugello - Nozzle
1 pc No.8 (010691) (d)





Elettrodi TIG - TIG Electrodes

Codice Code	Diametro Diameter	Quantità Quantity	Torcia Torch	Intensità corrente Current intensity	Gas di protezione Shielding gas	Metalli saldabili Weldable Metals	Tipo di corrente Type of current
WC20 Tungsteno/Cerio 2% Tungsten/Cerium 2%					Argon	Acciai ed Inox Steel and Stainless	
010694	∅ 1,6	10 pcs	110A, 140A, 180A, 320A	10 - 80 A			
010696	∅ 2,4	10 pcs	140A, 180A, 320A	90 - 120 A			
010668	∅ 3,2	10 pcs	140A, 180A, 320A	125 - 240 A			
010663	∅ 4,0	10 pcs	140A, 180A, 320A	125 - 240 A	Argon	Leghe Leggere Light Alloys	
WP Tungsteno puro Pure Tungsten							
010697	∅ 1,6	10 pcs	110A, 140A, 180A, 320A	40 - 80 A			
010699	∅ 2,4	10 pcs	140A, 180A, 320A	70 - 120 A			
010700	∅ 3,2	10 pcs	140A, 180A, 320A	125 - 240 A			
010662	∅ 4,0	10 pcs	180A, 320A	125 - 240 A			





Adattatore bombole ricaricabili/non ricaricabili
Adapter for refillable bottle/non refillable bottle

010810 (1 pc) 



Adattatore torcia TIG
TIG torch adapter

010820  25 mm² → 50 mm² (1 pc) 



Bombole non ricaricabili
Non refillable bottles

010503 Argon lt. 1 (1 pc)









Tubo gas
Gas Hose

000216 1,5 m (1 pc)





Cavo con pinza portaelettrodo
Cable with electrode holder

 010060 160A cavo 10 mm² (1,7m)  25 mm² (1 pc)
 010069 200A cavo 16 mm² (2,7m)  25 mm² (1 pc)
 010070 300A cavo 35 mm² (3m)  50 mm² (1 pc)



Cavo con morsetto di massa
Cable with earth clamp

010173 200A cavo 16 mm² (2,7m)  25 mm² (1 pc)
 010314 350A cavo 35 mm² (3m)  50 mm² (1 pc)
 010316 500A cavo 70 mm² (3m)  70 mm² (1 pc)

Torçe MIG e dotazione - MIG torches and equipment



010821 MIG 110A Valve 2 m - 110@35%
(MIGA 215)



010464 MIG 140A 2 m - 140@60%
(D-mig 230 AC)



010468 MIG 140A Valve 2 m - 140@60%
(D-mig 235 - D-mig 265)



010470 MIG 160A 2 m - 160@60%
(D-mig 350 - D-mig 380)



010822 DE 15E 3 m EURO - 180@60%
(MIGA 218 - 220 - 225XL - 380 - D-mig 390 - D-mig 420s
D-mig 5 Series - JOB Series)



	(a) Lancia - Lance		010824
	(b) Molla - Spring	(10 pcs)	010437
	(c) Ugello portacorrente - Contact tip \varnothing 1,0	(20 pcs)	010450
	(d) Ugello gas - Gas nozzle \varnothing 12	(5 pcs)	010443
	Ugello gas - Gas nozzle \varnothing 12	(2 pcs)	010252
	(e) Guaina guidafile - Liner Fe, Flux \varnothing 0,6 / 1,0	(1 pc)	010241



	(a) Lancia - Lance		010240
	(b) Molla - Spring	(10 pcs)	010437
	(c) Ugello portacorrente - Contact tip \varnothing 1,0	(20 pcs)	010450
	(d) Ugello gas - Gas nozzle \varnothing 12	(5 pcs)	010443
	Ugello gas - Gas nozzle \varnothing 12	(2 pcs)	010252
	(e) Guaina guidafile - Liner Fe, Flux \varnothing 0,6 / 1,0	(1 pc)	010241



	(a) Lancia - Lance		010485
	(b) Molla - Spring	(10 pcs)	010437
	(c) Ugello portacorrente - Contact tip \varnothing 1,0	(20 pcs)	010450
	(d) Ugello gas - Gas nozzle \varnothing 12	(5 pcs)	010443
	Ugello gas - Gas nozzle \varnothing 12	(2 pcs)	010252
	(e) Guaina guidafile - Liner Fe, Flux \varnothing 0,6 / 1,0	(1 pc)	010241



	(a) Lancia - Lance		010488
	(b) Molla - Spring	(10 pcs)	010437
	(c) Ugello portacorrente - Contact tip \varnothing 0,8	(20 pcs)	010449
	(d) Ugello gas - Gas nozzle \varnothing 12	(5 pcs)	010443
	Ugello gas - Gas nozzle \varnothing 12	(2 pcs)	010252
	(e) Guaina guidafile - Liner Fe \varnothing 1,0 / 1,2	(1 pc)	010744

Torçe MIG e dotazione - MIG torches and equipment

5



010828 DE 25E 3 m EURO - 230@60%
(Easy JOB 525 - JOB 635 - D-mig 635 - D-mig 735)

5

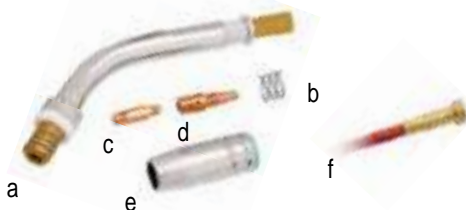

(a)	Lancia - Lance		010489
(b)	Molla - Spring	(10 pcs)	010436
(c)	Ugello portacorrente - Contact tip \varnothing 0,8 M6	(20 pcs)	010449
(d)	Diffusore gas - Gas diffuser	(10 pcs)	010997
(e)	Ugello gas - Gas nozzle \varnothing 15	(5 pcs)	010444
(f)	Guaina guidafile - Liner Fe \varnothing 1,0 / 1,2	(1 pc)	010744

6



010234 MIG 180A 3 m EURO - 180@60%
010235 MIG 180A 4 m EURO - 180@60%
(MIGA 218 - 220 - 225XL - 380 - D-mig 390 - D-mig 420s
D-mig 5 Series - JOB Series)

6



(a)	Lancia - Lance		010488
(b)	Molla - Spring	(10 pcs)	010437
(c)	Ugello portacorrente - Contact tip \varnothing 0,8	(20 pcs)	010449
(d)	Ugello gas - Gas nozzle \varnothing 12	(5 pcs)	010443
	Ugello gas - Gas nozzle \varnothing 12	(2 pcs) ☉	010252
(e)	Guaina guidafile - Liner Fe \varnothing 0,6 / 0,9	(1 pc)	010743



010372 MIG 180A POT3 3 m EURO "Tyco" - 180@60%
(JOB Series, D-mig 532 TDK)

7



010236 MIG 230A 3 m EURO - 230@60%
010237 MIG 230A 4 m EURO - 230@60%
(Easy JOB 525 - JOB 635 - D-mig 635 - D-mig 735)

7

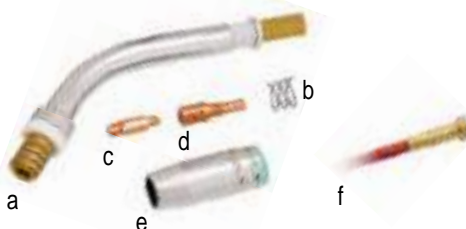

(a)	Lancia - Lance		010489
(b)	Molla - Spring	(10 pcs)	010436
(c)	Ugello portacorrente - Contact tip \varnothing 1,0 M6	(20 pcs)	010942
(d)	Diffusore gas - Gas diffuser	(10 pcs)	010997
(e)	Ugello gas - Gas nozzle \varnothing 15	(5 pcs)	010444
(f)	Guaina guidafile - Liner Fe \varnothing 1,0 / 1,2	(1 pc)	010744

8



010463 MIG 340A 3 m EURO - 340@60%
010239 MIG 340A 4 m EURO - 340@60%
(D-mig 650 - D-mig 660 - D-mig 750 - D-mig 760)

8



(a)	Lancia - Lance		010490
(b)	Ugello portacorrente - Contact tip \varnothing 1,2 M6	(20 pcs)	010943
(c)	Diffusore gas - Gas diffuser	(10 pcs)	010998
(d)	Porta punta - Collet body nozzle M6	(20 pcs)	010439
(e)	Ugello gas - Gas nozzle \varnothing 16	(5 pcs)	010445
(f)	Guaina guidafile - Liner Fe \varnothing 1,0 / 1,2	(1 pc)	010744

Torche MIG e dotazione - MIG torches and equipment

9



010461 MIG 500A H2O 3 m EURO - 500@100%
010462 MIG 500A H2O 4 m EURO - 500@100%
 (D-mig 7 Series)

9



- | | | | |
|-----|---|----------|---------------|
| (a) | Lancia - Lance | | 010492 |
| (b) | Ugello portacorrente - Contact tip \varnothing 1,2 M8 | (20 pcs) | 010947 |
| (c) | Diffusore gas - Gas diffuser | (10 pcs) | 010999 |
| (d) | Porta punta - Collet body nozzle M8 | (10 pcs) | 010405 |
| (e) | Ugello gas - Gas nozzle \varnothing 20 | (10 pcs) | 010406 |
| (f) | Guaina guidafile - Liner Fe \varnothing 1,2 / 1,6 | (1 pc) | 010745 |

10



010374 MIG SPOOL GUN4 180A 6 m EURO "Tyco" - 180@60%
 (JOB Series, D-mig 532 TDK)

10



- | | | | |
|-----|--|----------|---------------|
| (a) | Lancia - Lance | | 010484 |
| (b) | Molla - Spring | (10 pcs) | 010437 |
| (c) | Ugello portacorrente - Contact tip \varnothing 0,8 ALU | (20 pcs) | 010949 |
| (d) | Ugello gas - Gas nozzle \varnothing 12 | (5 pcs) | 010443 |
| (e) | Rullo trainafilo - Wire guide roller \varnothing 0,8/1,0 ALU | | 011199 |
| (f) | Guaina guidafile - Liner Teflon \varnothing 1,0 / 1,2 | (1 pc) | 010747 |

11



010071 MIG 180A 3 m EURO - 180@60%
 (JOB 524 T3)

11

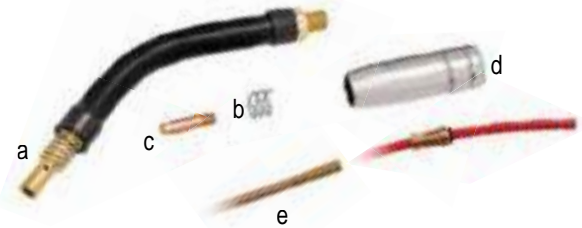

- | | | | |
|-----|---|-----------|---------------|
| (a) | Lancia - Lance | | 010488 |
| (b) | Molla - Spring | (10 pcs) | 010437 |
| (c) | Ugello portacorrente - Contact tip \varnothing 0,8 | (20 pcs) | 010449 |
| (d) | Ugello gas - Gas nozzle \varnothing 12 | (5 pcs) | 010443 |
| (e) | Ugello gas - Gas nozzle \varnothing 12 | (2 pcs) ☉ | 010252 |
| (f) | Guaina guidafile - Liner Teflon \varnothing 1,0 / 1,2 | (1 pc) | 010077 |

12



010074 MIG 230A 3 m EURO - 230@60%
 (JOB 524 T3)

12

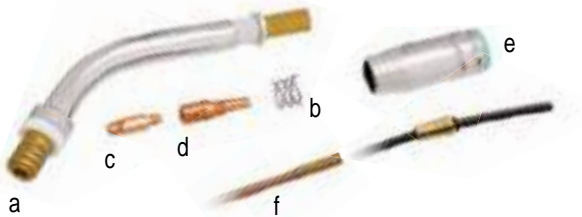

- | | | | |
|-----|--|----------|---------------|
| (a) | Lancia - Lance | | 010489 |
| (b) | Molla - Spring | (10 pcs) | 010436 |
| (c) | Ugello portacorrente - Contact tip \varnothing 1,0 Alu | (20 pcs) | 010992 |
| (d) | Diffusore gas - Gas diffuser | (10 pcs) | 010997 |
| (e) | Ugello gas - Gas nozzle \varnothing 15 | (5 pcs) | 010444 |
| (f) | Guaina guidafile - Liner Teflon \varnothing 1,0 / 1,2 | (1 pc) | 010078 |

MMA
TIG
MIG
PAC
MMA
TIG
MIG
PAC
CAR BODY REPAIR
Accessori
Accessories
Tech

Torche Torches			140A (010464)	110A Valve (010821) 140A Valve (010468)	180A (010470)	180A 3m EURO (010822) 180A 3m EURO (010234) 180A 4m EURO (010235) POT3 3m EURO (010372)	SPOOL GUN4 (010374)	230A 3m EURO (010828) 230A 3m EURO (010236) 230A 4m EURO (010237)	340A 3m EURO (010463) 340A 4m EURO (010239)	500A H2O 3m EURO (010461) 500A H2O 4m EURO (010462)
a Ugello portacorrente Acciaio - Contact tip Steel										
010448	(a) Fe M6 Ld	ø 0,6 (20 pcs)	-	●	●	●	●	●	●	-
010253	(a) Fe M6 Ld	ø 0,6 (3 pcs) ☉	-	●	●	●	●	●	●	-
010449	(a) Fe M6 Ld	ø 0,8 (20 pcs)	-	●	●	●	●	●	●	-
010254	(a) Fe M6 Ld	ø 0,8 (3 pcs) ☉	-	●	●	●	●	●	●	-
010450	(a) Fe M6 Ld	ø 1,0 (20 pcs)	●	●	●	●	●	●	●	-
010255	(a) Fe M6 Ld	ø 1,0 (3 pcs) ☉	●	●	●	●	●	●	●	-
010451	(a) Fe M6 Ld	ø 1,2 (20 pcs)	-	-	-	-	-	●	●	-
010942	(b) Fe M6 Hd	ø 1,0 (20 pcs)	-	-	-	-	-	●	●	-
010943	(b) Fe M6 Hd	ø 1,2 (20 pcs)	-	-	-	-	-	-	●	-
010944	(b) Fe M6 Hd	ø 1,6 (20 pcs)	-	-	-	-	-	-	●	-
010945	(c) Fe M8	ø 0,8 (20 pcs)	-	-	-	-	-	-	-	●
010946	(c) Fe M8	ø 1,0 (20 pcs)	-	-	-	-	-	-	-	●
010947	(c) Fe M8	ø 1,2 (20 pcs)	-	-	-	-	-	-	-	●
010948	(c) Fe M8	ø 1,6 (20 pcs)	-	-	-	-	-	-	-	●
a Ugello portacorrente Alluminio - Contact tip Aluminium										
010949	(b) Al M6	ø 0,8 (20 pcs)	-	●	●	●	●	●	●	-
010256	(b) Al M6	ø 0,8 (3 pcs) ☉	-	●	●	●	●	●	●	-
010992	(b) Al M6	ø 1,0 (20 pcs)	-	●	●	●	●	●	●	-
010257	(b) Al M6	ø 1,0 (3 pcs) ☉	-	●	●	●	●	●	●	-
010993	(b) Al M6	ø 1,2 (20 pcs)	-	-	-	-	-	●	●	-
010994	(c) Al M8	ø 1,0 (20 pcs)	-	-	-	-	-	-	-	●
010995	(c) Al M8	ø 1,2 (20 pcs)	-	-	-	-	-	-	-	●
010996	(c) Al M8	ø 1,6 (20 pcs)	-	-	-	-	-	-	-	●



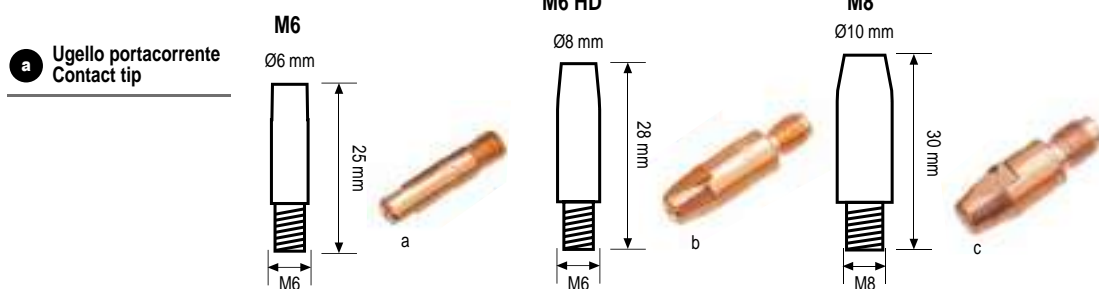



Fe = acciaio, steel Al = alluminio, aluminum



a Ugello portacorrente Contact tip

Torche / Torches 110A - 140A - 180A		
Guaina guidafile - Liner		
010241	Fe, Flux ø 0,6 / 1,0	3 m
010370	Al ø 0,8 / 1,0	3 m

Torche / Torches 180A - 500A altre / others			
Guaina guidafile - Liner			
010743	Fe	ø 0,6 / 0,9	4 m
010744	Fe	ø 1,0 / 1,2	4 m
010745	Fe	ø 1,2 / 1,6	4 m
010746	Al	ø 0,6 / 0,9	Teflon 3 m
010747	Al	ø 1,0 / 1,2	Teflon 3 m
010077	Al CuSi3	ø 1,0 / 1,2	Teflon 3 m
010078	Al	ø 1,0 / 1,2 Grafite	Teflon 3 m
010384	Al	ø 1,0 / 1,2 Grafite	Teflon 4 m
010080	Al	ø 1,2 / 1,6	Teflon 4 m

			MIGA 215	MIGA 218 - 220	MIGA 225 XL - 380	EASY JOB 525 LAB	JOB 220 LAB	JOB 522 LAB JOB 523 LAB JOB 522P LAB JOB 523P LAB JOB 524 T3 JOB 635	D-mig 230 AC	D-mig 235 - 265 D-mig 350 - 380	D-mig 390	D-mig 400 Series	D-mig 500 LAB Series	D-mig 600 LAB Series D-mig 700 LAB Series
Rullino trainafilo - Wire guide roller														
A		Ø 25												
011251	Fe ø 0,8 / 1,0	(1 pc)	●	●	-	-	-	-	-	-	-	-	-	-
011250	Flux ø 0,9 / Fe ø 0,6	(1 pc)	●	●	-	-	-	-	-	-	-	-	-	-
011252	Al ø 0,8 / 1,0 / 1,2	(1 pc)	●	●	-	-	-	-	-	-	-	-	-	-
B		Ø 30												
011214	Fe ø 0,6 / 0,8	(1 pc)	-	-	●	●	●	-	-	-	-	-	-	-
011215	Fe ø 1,0 / 1,2	(1 pc)	-	-	●	●	●	-	-	-	-	-	-	-
011218	Flux ø 0,9 / 1,0	(1 pc)	-	-	●	●	●	-	-	-	-	-	-	-
011219	Flux ø 1,0 / 1,2	(1 pc)	-	-	●	●	●	-	-	-	-	-	-	-
011216	Al ø 0,8 / 1,0	(1 pc)	-	-	●	●	●	-	-	-	-	-	-	-
011217	Al ø 1,0 / 1,2	(1 pc)	-	-	●	●	●	-	-	-	-	-	-	-
C		Ø 37												
011220	Fe ø 0,6 / 0,8	(2 pcs)	-	-	-	-	-	●	-	-	-	-	-	-
011221	Fe ø 1,0 / 1,2	(2 pcs)	-	-	-	-	-	●	-	-	-	-	-	-
011222	Al ø 0,8 / 1,0	(2 pcs)	-	-	-	-	-	●	-	-	-	-	-	-
011223	Al ø 1,0 / 1,2	(2 pcs)	-	-	-	-	-	●	-	-	-	-	-	-
011224	Flux ø 0,9 / 1,0 / 1,2	(2 pcs)	-	-	-	-	-	●	-	-	-	-	-	-
D		Ø 20												
010841	KIT: Fe ø 0,6/0,8/1,0 Flux ø 0,8/0,9/1,2 Al ø 0,8/1,0	Blister 3 pcs ☉						-	-	●	●	●	-	-
010776	Fe ø 0,6	(1 pc)	-	-	-	-	-	-	-	●	●	●	-	-
010673	Fe ø 0,8 / 1,0 (Al ø 0,8 / 1,0)	(1 pc)	-	-	-	-	-	-	-	●	●	●	-	-
010775	Flux ø 0,8 / 0,9 / 1,2	(1 pc)	-	-	-	-	-	-	●	●	●	-	-	-
E		Ø 30												
010647	Fe ø 0,6 / 0,8	(1 pc)	-	-	-	-	-	-	-	-	-	-	●	-
010628	Fe ø 1,0 / 1,2	(1 pc)	-	-	-	-	-	-	-	-	-	-	●	-
010629	Al ø 0,8 / 1,0	(1 pc)	-	-	-	-	-	-	-	-	-	-	●	-
010627	Flux ø 0,9	(1 pc)	-	-	-	-	-	-	-	-	-	-	●	-
G		Ø 30												
011206	Fe ø 0,8 / 1,0	(2 pcs)	-	-	-	-	-	-	-	-	-	-	-	●
011207	Fe ø 1,2 / 1,6	(2 pcs)	-	-	-	-	-	-	-	-	-	-	-	●
011208	Al ø 0,8 / 1,0	(2 pcs)	-	-	-	-	-	-	-	-	-	-	-	●
011209	Al ø 1,2 / 1,6	(2 pcs)	-	-	-	-	-	-	-	-	-	-	-	●
011210	Flux ø 1,2 / 1,6	(2 pcs)	-	-	-	-	-	-	-	-	-	-	-	●
011198	Fe ø 0,6 / 0,8	SPOOL GUN (1 pc)	-	-	-	-	-	-	-	-	-	-	-	-
011199	Al ø 0,8 / 1,0	SPOOL GUN (1 pc)	-	-	-	-	-	-	-	-	-	-	-	-



010515 CO₂ (1 pc) ☉



010499 CO₂ (1 pc) ☉



010242 CO₂ (1 pc)



010513 CO₂ (1 pc)



010512 CO₂ (1 pc)



010517 CO₂ (1 pc)



010571 CO₂ → Ar (1 pc)

Riduttore pressione
Pressure reducer

Anti Stick Spray



010621 (1 pc)



Bombole non ricaricabili
Non refillable bottles

010501	CO ₂	lt. 1	(1 pc)
010502	Argon/CO ₂	lt. 1	(1 pc)
010503	Argon	lt. 1	(1 pc)



Adattatore bombole ricaricabili/non ricaricabili
Adapter for refillable bottle/non refillable bottle

010810 (1 pc) ☉

Tubo gas
Gas Hose



000216 1,5m (1 pc)



Torçe PAC e dotazione - PAC torches and equipment

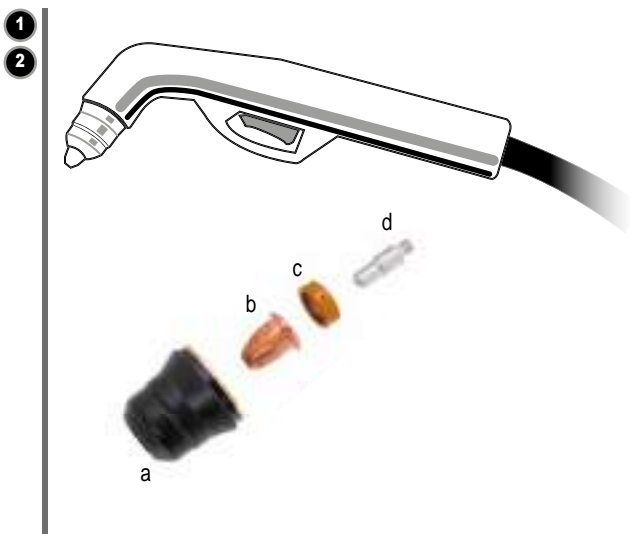

1 010826 PAC Torch DE 25 4 m
(I-PAC 340)

(a)	Porta ugello 6 fori - Nozzle holder 6 holes	010186	(4 pcs)
(b)	Ugello-Nozzle \varnothing 0,6 mm 20A	010961	(10 pcs)
(c)	Ugello-Nozzle \varnothing 0,8 mm 30A	010183	(10 pcs)
(c)	Diffusore aria-Swirl	010179	(2 pcs)
(d)	Elettrodo-Electrode	010180	(10 pcs)



2 010829 PAC Torch DE 25K 4 m
(I-PAC 335K)

(a)	Porta ugello 4 fori - Nozzle holder 4 holes	010198	(4 pcs)
(b)	Ugello-Nozzle \varnothing 0,6 mm 20A	010961	(10 pcs)
(b)	Ugello-Nozzle \varnothing 0,8 mm 30A	010183	(10 pcs)
(c)	Diffusore aria-Swirl	010179	(2 pcs)
(d)	Elettrodo-Electrode	010180	(10 pcs)

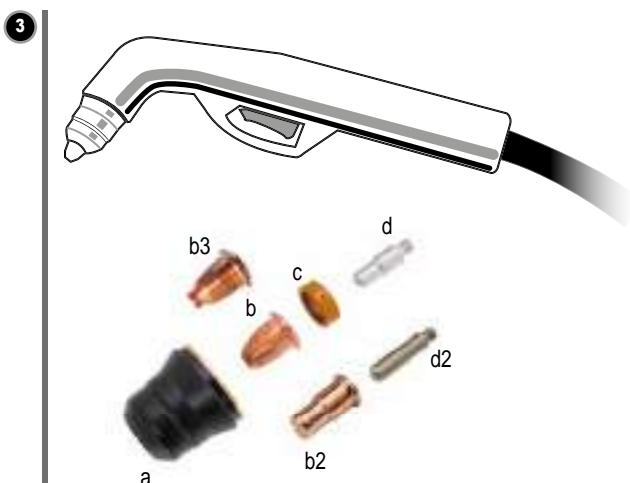

3 010830 PAC Torch DE 50 4 m
(I-PAC 350 LAB)

(a)	Porta ugello 6 fori - Nozzle holder 6 holes	010186	(4 pcs)
(b)	Ugello-Nozzle \varnothing 0,6 mm 20A	010961	(10 pcs)
(b)	Ugello-Nozzle \varnothing 0,8 mm 30A	010183	(10 pcs)
(b)	Ugello-Nozzle \varnothing 0,9 mm 50A	010123	(10 pcs)
(b2)	Ugello-Nozzle \varnothing 0,9 mm 50A	010185	(10 pcs)
(b3)	Ugello-Nozzle Gouging	010525	(10 pcs)
(c)	Diffusore aria-Swirl	010179	(2 pcs)
(d)	Elettrodo-Electrode	010180	(10 pcs)
(d2)	Elettrodo-Electrode	010182	(10 pcs)



1 ■ 010082 KIT STARTER

2

3 pcs Ugello-Nozzle \varnothing 0,8 mm	(010183)	(a)
1 pc Diffusore aria-Swirl	(010179)	(b)
3 pcs Elettrodo-Electrode	(010180)	(c)

3 ■ 010084 KIT STARTER

3 pcs Ugello-Nozzle \varnothing 0,8 mm 30A	(010183)	(a)
3 pcs Ugello-Nozzle \varnothing 0,9 mm 50A	(010123)	(a)
1 pc Diffusore aria-Swirl	(010179)	(b)
3 pcs Elettrodo-Electrode	(010180)	(c)
1 pc Ugello-Nozzle Gouging	(010525)	(d)

Torçe PAC e dotazione - PAC torches and equipment



1

010228 PAC Torch 40A 6 m
(D-PAC 60 LAB)

- | | | |
|--|---|------------------------|
| | (a) Porta ugello 6 fori - Nozzle holder 6 holes | 010186 (4 pcs) |
| | (b) Ugello-Nozzle ø 0,8 mm (30A) | 010183 (10 pcs) |
| | (b) Ugello-Nozzle ø 0,9 mm (50A) | 010123 (10 pcs) |
| | (c) Diffusore aria-Swirl | 010179 (2 pcs) |
| | (d) Elettrodo-Electrode | 010180 (10 pcs) |



2

010393 PAC Torch 80A 6 m
(D-PAC 90 LAB)

- | | | |
|--|------------------------------------|------------------------|
| | (a) Porta ugello-Nozzle holder | 010120 (2 pcs) |
| | (b) Ugello-Nozzle ø 1,0 mm (50A) | 010118 (10 pcs) |
| | (b) Ugello-Nozzle ø 1,2 mm (80A) | 010119 (10 pcs) |
| | (c) Diffusore aria-Swirl | 010117 (2 pcs) |
| | (d) Elettrodo-Electrode | 010116 (10 pcs) |
| | (e) Molla distanziale-Spacing ring | 010121 (10 pcs) |



3

010909 PAC Torch 100A 6 m
(D-PAC 120 LAB)

- | | | |
|--|---|------------------------|
| | (a) Porta ugello-Nozzle holder | 010431 (2 pcs) |
| | (b) Ugello-Nozzle ø 1,1 mm (60A) | 010122 (10 pcs) |
| | (b) Ugello-Nozzle ø 1,4 (100A) | 010434 (10 pcs) |
| | (b) Ugello-Nozzle ø 1,7 (130A) | 010433 (10 pcs) |
| | (b) Ugello-Nozzle ø 3,0 (gouging) | 010432 (10 pcs) |
| | (c) Diffusore aria-Swirl | 010684 (2 pcs) |
| | (d) Elettrodo-Electrode | 010435 (10 pcs) |
| | (e) Molla distanziale-Spacing ring | 010425 (10 pcs) |
| | (f) Distanziale a 2 punte-Spacing bush with 2 feet | 010680 (2 pcs) |
| | (g) Carrello per taglio-Wheeled spacer | 010685 (1 pcs) |
| | (h) Distanziale per scricatura-Gouging spacer | 010683 (2 pcs) |
| | (i) Distanziale taglio a contatto-Spacer for bearing cutting | 010427 (10 pcs) |
| | (l) Portaugello per taglio a contatto-Bearing cutting nozzle holder | 010429 (2 pcs) |



Note tecniche

Technical tips



Macchine per saldatura ad arco elettrico e taglio al plasma

Electric arc welding and plasma cutting machines

Le macchine per saldare ad arco o per tagliare al plasma i metalli trasformano i parametri elettrici della rete di distribuzione in modo da ottenere valori di tensione e corrente idonei per generare un arco di saldatura o taglio.

Nelle soluzioni **TRADIZIONALI** si impiegano trasformatori in lamierino magnetico alla frequenza di rete e la regolazione della potenza di lavoro avviene tramite:

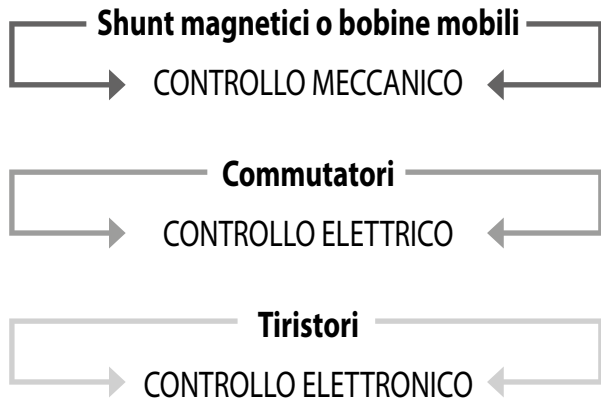

Nell'ultimo decennio del secolo scorso si è affermata una diversa tecnologia per la realizzazione dei generatori alla quale ci riferiamo comunemente con il termine **INVERTER**.

La tecnologia inverter prevede di aumentare la frequenza della corrente alternata prelevata dalla rete (da 50Hz fino a valori di decine di KHz) prima di trasformarla ed ottenere un valore idoneo alla saldatura o al taglio plasma.

La trasformazione di una corrente a frequenza elevata non richiede l'impiego del trasformatore tradizionale in lamierino magnetico, molto grande e pesante, ma di un trasformatore con nucleo in ferrite, piccolo e leggero.

L'applicazione di questa tecnologia alle saldatrici ed ai generatori per il taglio al plasma permette di produrre apparecchi maneggevoli e di ridotte dimensioni, in grado comunque di erogare correnti di valore elevato.

Il controllo della potenza degli inverter si effettua in modo elettronico e permette la realizzazione di sistemi molto precisi e stabili, ovvero semplici da usare per gli operatori del settore.

The machines for metal arc welding or plasma cutting transform the electrical parameters of the distribution network in order to obtain suitable voltage and current values to generate a welding arc or cut.

In **TRADITIONAL** solutions, magnetic sheet metal transformers are used at the mains frequency and the working power is regulated by:

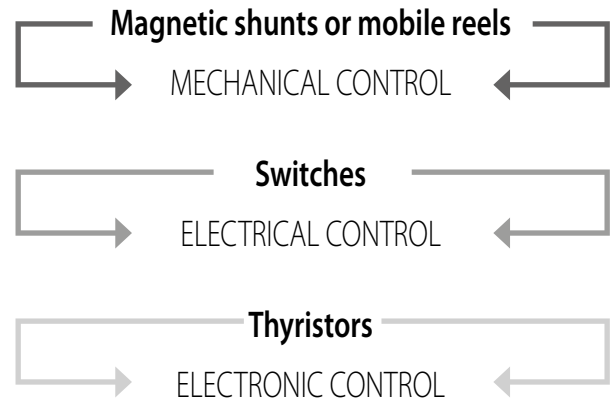

In the last decade of the last century a new technology emerged for the production of generators, which we generally refer to with the term **INVERTER**.

The inverter technology implies increasing the frequency of the alternating current taken from the network (from 50Hz up to tens of KHz) before transforming it and obtaining a suitable value for welding or plasma cutting.

The transformation of a high frequency current does not require the use of a traditional magnetic sheet steel transformer, which is very big and heavy, but a ferrite core transformer, which is small and lightweight.

Through the application of this technology to welding machines and generators for plasma cutting, it is possible to produce easy-to-handle and compact devices, which can still supply high value currents.

The inverter power is controlled electronically and allows for the implementation of highly precise and stable systems, which are simple to use for operators in the sector.



MMA Saldatura a elettrodo rivestito

Manual metal arc welding



La saldatura ad elettrodo rivestito **MMA** (Manual Metal Arc) sfrutta il calore generato da un arco che scocca tra l'elettrodo ed il pezzo da saldare. E' probabilmente la tecnologia più diffusa a livello mondiale per la saldatura manuale ad arco elettrico.

Con questo procedimento si saldano comunemente tutti i metalli ferrosi, ovvero il **ferro**, i diversi tipi di **acciaio**, compreso l'**acciaio inox**, e la **ghisa**. Con gli altri metalli si ottengono risultati scadenti, per alcuni la saldatura ad elettrodo risulta impossibile. La produttività di questo procedimento è limitata: è necessario interrompere la saldatura quando l'elettrodo è consumato ed occorre sostituirlo, inoltre si deve rimuovere la scoria dopo ogni singola passata.

Vantaggi

Saldature in qualunque posizione
Saldature all'interno ed all'aperto
Maneggevolezza del porta-elettrodo
(no gas, no liquidi raffreddamento)
Apparecchiatura semplice

Svantaggi

Bassa produttività
Richiede buona manualità

Advantages

Welding in any position
Welding indoors and outdoors
Handy electrode holder
(no gas, no cooling liquids)
Simple equipment

Disadvantages

Low productivity
Requires good dexterity

Manual metal arc welding (**MMA**) exploits the heat generated by an arc which shoots out between the electrode and the piece to be welded. It is probably the most widespread technology in the world for manual electric arc welding.

This process is used to weld all ferrous metals, namely **iron**, various types of **steel**, including **stainless steel**, and **cast iron**. With other metals poor results are obtained. For some of them, manual metal arc welding is impossible. The productivity of this process is limited: it is necessary to interrupt welding when the electrode is worn and this must be replaced. Moreover, the slag must be removed after every single weld.

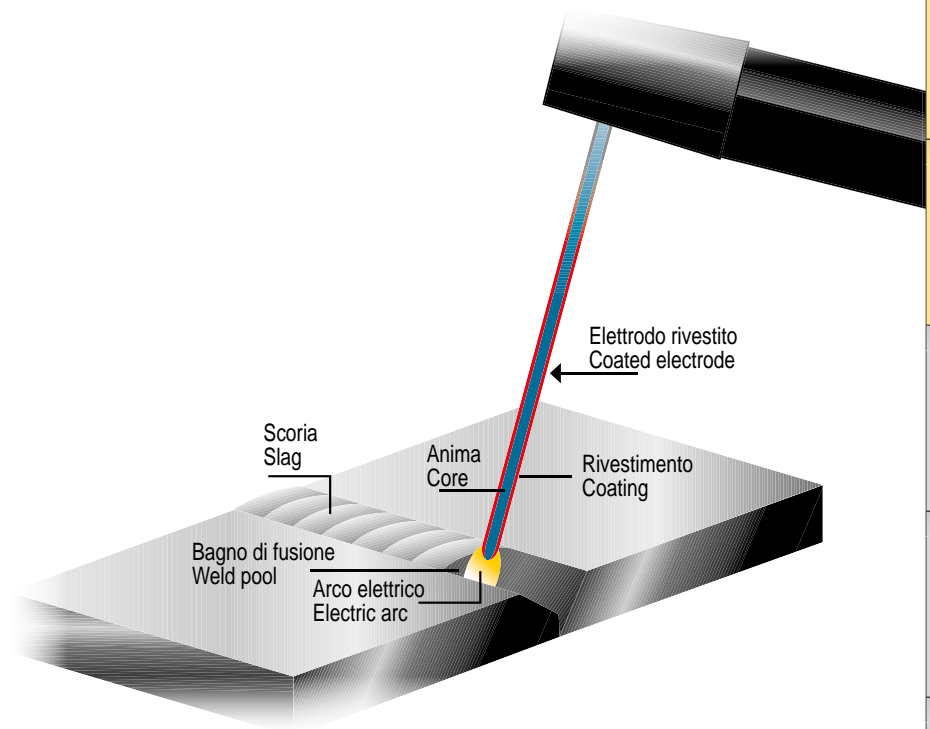

ARC FORCE

Incremento dinamico della corrente di saldatura quando l'arco diventa troppo corto. Previene l'incollaggio dell'elettrodo al pezzo da saldare. Può essere regolabile dall'operatore, oppure predisposto in fase di progetto in modo che intervenga automaticamente.

ARC FORCE

Dynamic increase of welding current when the arc becomes too short. It prevents the electrode from sticking to the piece to be welded. It can be adjusted by the operator, or arranged during design so that it is engaged automatically.

ANTISTICKING

Riduzione drastica della corrente di saldatura quando l'elettrodo si incolla al pezzo, ovvero la tensione d'arco è nulla per un tempo che supera il limite impostato in fase di progetto. Facilita la rimozione dell'elettrodo dal pezzo da saldare ed evita il surriscaldamento del circuito secondario di saldatura.

ANTISTICKING

Drastic welding current reduction when the electrode sticks to the piece, i.e. the arc voltage is zero for a time that exceeds the limit set during design. It facilitates the removal of the electrode from the piece to be welded and prevents overheating of the secondary welding circuit.

HOT START

Incremento della corrente di saldatura al momento dell'innesco, facilita l'accensione dell'arco. Può essere automatico oppure regolabile dall'operatore.

HOT START

Welding current increase at the time of striking. It facilitates arc starting. It can be automatic or adjusted by the operator.

MMA

TIG

MIG

PAC

MMA

TIG

MIG

PAC

CAR BODY REPAIR

Accessori Accessories

Tech

La saldatura **TIG** (Tungsten Inert Gas) sfrutta il calore generato da un arco elettrico che scocca tra il pezzo da saldare ed un elettrodo infusibile di tungsteno, sotto la protezione di un gas inerte, comunemente argon o miscele di Argon-Elio.

La saldatura può avvenire senza materiale d'apporto oppure con apporto di materiale che si effettua tramite bacchetta TIG omogenea con il metallo da saldare.

Il procedimento TIG può essere impiegato per la saldatura di tutti i metalli, in particolare:

Inox **Rame**
Ottone **Bronzo**
Titanio **Nichel**
Alluminio e sue leghe
Leghe al magnesio

Questo procedimento assicura ottimi risultati meccanici ed estetici, consentendo esecuzioni molto precise.

La produttività non è particolarmente elevata.

Vantaggi

Qualità meccanica elevata del giunto saldato
Aspetto estetico del cordone (saldature a vista)
Saldature di precisione
Spessori sottili

Svantaggi

Richiede buona manualità
Bassa produttività
Apparecchiatura complessa

Advantages

High mechanical quality of the welded joint
Aesthetic look of the seam (visible welding)
Precision welding
Small thicknesses

Disadvantages

Requires dexterity
Low productivity
Complex equipment

TIG welding (Tungsten Inert Gas Welding) exploits the heat generated by an arc which shoots out between the piece to be welded and an infusibile tungsten electrode, under the protection of an inert gas, which is commonly argon or an argon-helium mixture.

Welding can be without filler material or with the addition of material through a TIG rod that is homogeneous with the metal to be welded. The TIG process can be used for welding all metals, and in particular:

Stainless steel **Copper**
Brass **Bronze**
Titanium **Nickel**
Aluminum and its alloys
Magnesium alloys

This process ensures excellent mechanical and aesthetic results, with highly precise performance. Productivity is not particularly high.

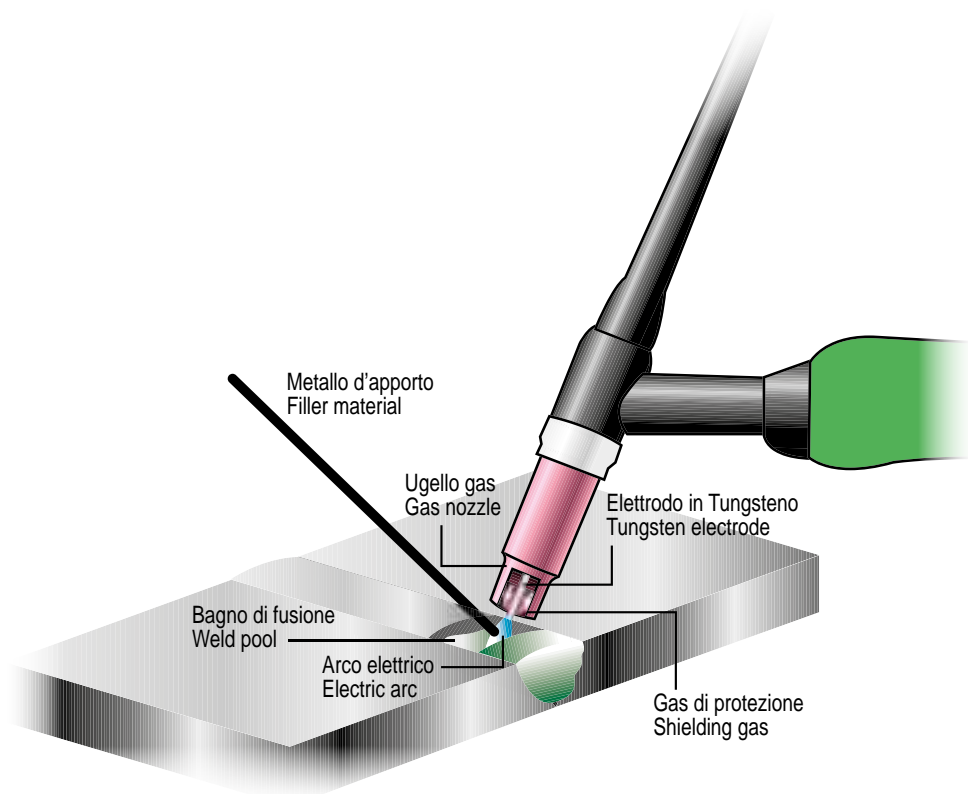

TIG AC

La polarità della corrente di saldatura è alternata (AC = Alternating Current).

Il generatore alterna i poli in uscita con frequenza opportuna.

Si usa per l'alluminio e per le leghe al magnesio.

Si preferisce un elettrodo in tungsteno puro.

TIG DC

La polarità della corrente di saldatura è continua (DC = Direct Current). L'elettrodo ha sempre polarità negativa, la fase di fusione è continua.

Si usa per tutti i metalli tranne l'alluminio e le leghe al magnesio.

Si preferisce un elettrodo in tungsteno con 2% di cerio.

TIG AC

The polarity of the welding current is alternating (AC = Alternating Current).

The generator alternates the output poles with a suitable frequency.

It is used for aluminum and magnesium alloys.

A pure tungsten electrode is preferred.

TIG DC

The polarity of the welding current is direct (DC = Direct Current). The electrode always has a negative polarity, and the melting phase is continuous.

It is used for all metals except aluminum and magnesium alloys.

A tungsten electrode with 2% cerium is preferred.

INNESCO HF

L'innescò dell'arco avviene senza contatto tra elettrodo e pezzo. Evitare tale contatto è importante, perché eventuali residui di tungsteno nel bagno di saldatura possono essere causa di difetti meccanici del giunto saldato.

HF STRIKING

Arc striking occurs without contact between the electrode and the piece. Avoiding such contact is important because any tungsten residues in the welding bath can cause mechanical defects in the welded joint.

INNESCO LIFT

Si appoggia l'elettrodo al pezzo e lo si solleva lentamente per innescare l'arco di saldatura, il rischio di contaminazione da tungsteno è modesto.

LIFT STRIKING

The electrode is placed on the piece and lifted slowly to strike the welding arc; the risk of tungsten contamination is modest.

INNESCO A STRISCIO

Si deve strofinare l'elettrodo sul pezzo per innescare. Si perde precisione e il rischio di contaminazione da tungsteno è elevato.

SCRATCH STRIKING

The electrode must be rubbed on the piece for starting. Lower precision is obtained and the risk of tungsten contamination is high.

RAMPA DI SALITA

Tempo in cui la corrente passa dal valore iniziale successivo all'innescò al valore impostato per la saldatura. Consente di evitare un inizio brusco della fusione.

SLOPE UP

Time in which the current goes from the initial value following striking to the value set for welding. It prevents an abrupt melting start.

RAMPA DI DISCESA (CRATER FILLER)

Tempo in cui la corrente passa dal valore impostato per la saldatura al valore di spegnimento. Evita la formazione del «cratere» al termine del cordone.

SLOPE DOWN (CRATER FILLER)

Time in which the current goes from the value set for welding to the end-weld value. It prevents the formation of the "crater" at the end of the seam.

BILANCIAMENTO

Distribuzione del tempo tra fase di pulizia e fase di fusione durante la saldatura TIG AC. A maggiore fusione corrisponde maggiore penetrazione della saldatura, ma minore pulizia del cordone.

BALANCING

Time distribution between cleaning phase and melting phase during TIG AC welding. Higher melt corresponds to greater penetration of the weld, but lower cleaning of the seam.

FREQUENZA AC

Numero di volte per unità di tempo in cui la polarità dell'elettrodo passa da positiva a negativa e viceversa in TIG AC. Maggiore frequenza corrisponde a cordoni più stretti e maggiore velocità di avanzamento.

AC FREQUENCY

Number of times per unit of time when the polarity of the electrode changes from positive to negative and vice versa in TIG AC. Higher frequency corresponds to narrower seams and greater forward speed.

BI-LEVEL

La corrente di saldatura passa dal valore impostato a un valore ridotto e viceversa ad ogni pressione del pulsante torcia. Si usa per dosare l'apporto termico al pezzo da saldare evitando crateri e sfondamenti. Molto utilizzato in caso di saldature di oggetti con spessore irregolare.

BI-LEVEL

The welding current changes from the set value to a reduced value and vice versa each time the torch button is pressed. It is used to dose the heat input to the piece to be welded avoiding craters and breakages. Widely used in case of welding objects with uneven thickness.

TIG PULSATO

La corrente di saldatura passa di continuo dal valore impostato (= corrente di picco) a un valore ridotto (= corrente di base) e viceversa. Si usa per dosare l'apporto termico al pezzo da saldare evitando crateri e sfondamenti. Utilizzato in caso di cordoni regolari di spessore sottile.

PULSE TIG

The welding current goes continuously from the set value (= peak current) to a reduced value (= base current) and vice versa. It is used to dose the heat input to the piece to be welded avoiding craters and breakages. Used in case of even seams with small thickness.

FREQUENZA PULSAZIONE

Numero di volte per unità di tempo in cui la corrente passa dal valore di picco al valore di base e viceversa in TIG pulsato. Maggiore frequenza corrisponde a cordoni più stretti e maggiore velocità di avanzamento.

PULSATION FREQUENCY

Number of times per unit of time in which the current goes from the peak value to the base value and vice versa in pulse TIG. Higher frequency corresponds to narrower seams and greater forward speed.

PRE-GAS

Tempo durante il quale il gas di protezione esce dall'ugello della torcia prima dell'innescò. Serve a creare un'atmosfera protettiva nella zona dove sta per iniziare la fusione.

PRE-GAS

Time during which the protection gas comes out of the torch nozzle before starting. It creates a protective atmosphere in the area where melting is about to begin.

POST-GAS

Tempo durante il quale il gas di protezione esce dall'ugello della torcia dopo lo spegnimento dell'arco al termine della saldatura. Serve a proteggere il bagno fuso fino alla completa solidificazione.

POST-GAS

Time during which the protection gas comes out of the torch nozzle after the arc switches off at the end of welding. It protects the molten bath until complete solidification.

2T/4T

Modalità di funzionamento del pulsante torcia: in 2T il pulsante viene tenuto premuto durante la saldatura, in 4T si preme il pulsante per iniziare a saldare, si salda con il pulsante rilasciato, si preme di nuovo per interrompere la saldatura.

2T/4T

Torch button operation mode: in the 2T mode the button is kept pressed during welding; in the 4T mode the button is pressed to start welding, which is then performed after the button is released, and it is pressed again to stop welding.

EASY PULSE by

Regolazione automatica della corrente base e della frequenza di pulsazione in funzione della corrente di picco impostata.

Semplifica notevolmente il procedimento di saldatura TIG con corrente pulsata.

Automatic regulation of the base current and the pulsation frequency according to the set peak current.

It considerably simplifies the TIG welding process with pulse current.

AC EASY by

Regolazione automatica della frequenza e del bilanciamento dell'onda alternata in funzione della corrente impostata per la saldatura dell'alluminio.

Semplifica notevolmente il procedimento di saldatura TIG con corrente alternata.

Automatic regulation of the frequency and the balance of the alternating wave according to the current set for welding aluminum.

It considerably simplifies the TIG welding process with alternating current.

MIG Saldatura a filo continuo

Continuous wire welding



La saldatura **MIG/MAG** (Metal Inert/Active Gas) sfrutta il calore generato da un arco elettrico che scocca tra il pezzo da saldare ed un filo elettrodo fusibile che costituisce il materiale d'apporto.

Il filo è avvolto in bobine di varie dimensioni e deve essere alimentato di continuo nel bagno di saldatura tramite un impianto opportuno.

La fusione è protetta dalla contaminazione atmosferica da un flusso di gas inerte (Argon) o attivo (miscele di Argon ed ossigeno, anidride carbonica), condotto nella zona di saldatura tramite la stessa torcia che guida il filo.

Il filo è di metallo pieno oppure è costituito da un tubo sottile riempito di flusso granulare fusibile che migliora le caratteristiche meccaniche del giunto saldato.

Alcuni tipi di filo tubolare possono essere usati senza protezione gassosa e pertanto vengono identificati con la sigla NO-GAS. Al termine della saldatura con filo animato è necessario rimuovere la scoria in superficie, il filo pieno invece non genera scoria.

Il procedimento MIG/MAG si impiega comunemente per la saldatura di:

Ferro ed altri acciai non legati

Acciai legati ed inossidabili

Alluminio e sue leghe

Vantaggi

- Elevata produttività
- No cambio elettrodo
- No rimozione scoria (filo pieno)
- Buona visibilità del bagno di fusione (rispetto ad MMA)
- Spessori alti con passata singola o più passate, grazie al deposito elevato
- Spessori sottili, diametro minimo filo in commercio 0,6mm

Svantaggi

- Apparecchiatura complessa
 - Generatore corrente - Aspo
 - Rulli motorizzati per trascinamento filo - Torcia - Bombola gas
 - Eventuale impianto raffreddamento ad acqua della torcia
- La regolazione contemporanea della tensione d'arco, della corrente di saldatura e della velocità di alimentazione del filo al bagno fuso è complicata e richiede esperienza.

MIG/MAG welding (Metal Inert/Active Gas Welding) exploits the heat generated by an arc which shoots out between the piece to be welded and a fusible wire electrode that constitutes the filler material.

The wire is wound in coils of various sizes and must be continuously fed into the welding bath by means of a suitable system.

Melting is protected from atmospheric contamination by an inert (Argon) or active (mixtures of Argon and oxygen, carbon dioxide) gas flow, conveyed to the welding area by the same torch that guides the wire.

The wire is made of solid metal or consists of a thin tube filled with a fusible granular flow which improves the mechanical characteristics of the welded joint.

Some types of tubular wire can be used without gas protection and are therefore identified with the initials NO-GAS. At the end of cored wire welding it is necessary to remove the slag on the surface; instead, the solid wire does not generate any slag.

The MIG/MAG process is commonly used for welding:

Iron and other non-alloy steel

Alloy and stainless steel

Aluminum and its alloys

Advantages

- High productivity
- No electrode change
- No slag removal (solid wire)
- Good visibility of the melting bath (compared to MMA)
- High thicknesses with single weld or more welds, thanks to the high deposit
- Thin thicknesses, minimum wire diameter on the market 0.6 mm

Disadvantages

- Complex equipment
 - Current generator - Reel
 - Motorized rollers for wire guiding - Torch - Gas cylinder
 - Possible water cooling system of the torch
- The simultaneous adjustment of the arc voltage, the welding current and the feeding speed of the wire to the molten bath is complicated and requires experience.

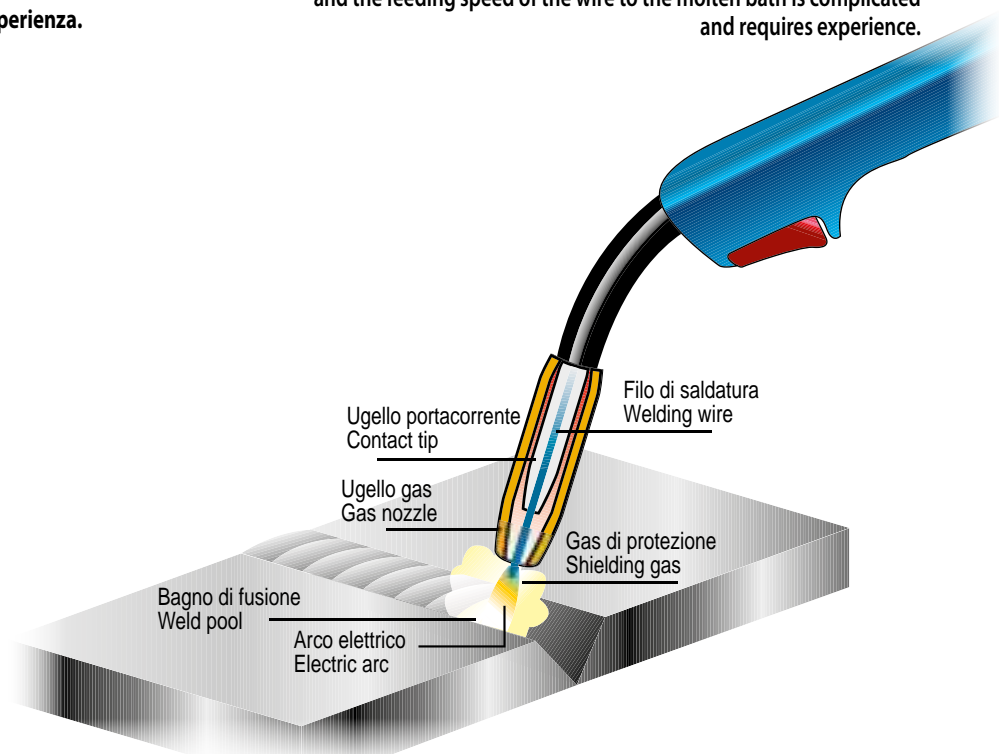

SOFT START

Tempo in cui il motore del trainafilo passa da fermo alla velocità impostata per la saldatura. Evita partenze troppo brusche. Può essere regolabile dall'operatore, oppure predisposto in fase di progetto in modo che intervenga automaticamente.

SOFT START

Time in which the wire guide motor passes from idle to the set welding speed. It prevents abrupt starts. It can be regulated by the operator, or arranged during design, so that it is engaged automatically.

BURN BACK

Tempo di ritardo tra l'arresto del motore e l'interruzione della potenza in uscita. Consente la regolazione della lunghezza del filo che esce dall'ugello al termine della saldatura. Può essere regolabile dall'operatore, oppure predisposto in fase di progetto in modo che intervenga automaticamente.

BURN BACK

Delay time between motor stop and output power cutoff. It allows adjusting the length of the wire that comes out of the nozzle at the end of welding. It can be regulated by the operator, or arranged during design, so that it is engaged automatically.

HOT START

Incremento della corrente durante l'innesco. Facilita l'innesco, in particolare quando si saldano leghe di alluminio. E' presente in genere nelle macchine a tecnologia INVERTER.

HOT START

Increase in current during striking. It facilitates striking, especially when welding aluminum alloys. It is usually present in INVERTER technology machines.

PRE-GAS

Tempo durante il quale il gas di protezione esce dall'ugello della torcia prima dell'innesco. Serve a creare un'atmosfera protettiva nella zona dove sta per iniziare la fusione.

PRE-GAS

Time during which the protection gas comes out of the torch nozzle before striking. It creates a protective atmosphere in the area where melting is about to begin.

POST-GAS

Tempo durante il quale il gas di protezione esce dall'ugello della torcia dopo lo spegnimento dell'arco al termine della saldatura. Serve a proteggere il bagno fuso fino alla completa solidificazione.

POST-GAS

Time during which the protection gas comes out of the torch nozzle after the arc switches off at the end of welding. It protects the molten bath until complete solidification.

2T/4T

Modalità di funzionamento del pulsante torcia: in 2T il pulsante viene tenuto premuto durante la saldatura, in 4T si preme il pulsante per iniziare a saldare, si salda con il pulsante rilasciato, si preme di nuovo per interrompere la saldatura.

2T/4T

Torch button operation mode: in the 2T mode the button is kept pressed during welding; in the 4T mode the button is pressed to start welding, which is then performed after the button is released, and it is pressed again to stop welding.

SPOOL GUN

Torcia particolare che permette di alloggiare la bobina di filo direttamente nell'impugnatura. Evita problemi di scorrimento del filo, in particolare nel caso si usi quello d'alluminio, e permette lunghezze maggiori del cavo torcia. Spesso usata in carrozzeria.

SPOOL GUN

Particular torch that allows housing the wire coil directly in the handle. It prevents wire sliding problems, especially in case aluminum wire is used, and allows for greater lengths of the torch cable. Often used in body shops.

MIG-BRAZING

Tecnica di saldatura a filo che prevede l'uso di impianti e consumabili che consentono di saldare a temperature non troppo elevate in modo che l'eventuale trattamento di zincatura della lamiera da saldare venga preservato il più possibile. Utilizzata comunemente in carrozzeria.

MIG-BRAZING

Welding technique involving the use of systems and consumables that allow welding at not too high temperatures, so that any galvanizing treatment of the sheet to be welded is preserved as much as possible. Commonly used in body shops.

PUNTATURA

Modalità di saldatura che permette di eseguire tratti saldati brevi e regolari. In genere si ottiene impostando il tempo di punto ed il tempo di pausa.

SPOT WELDING

Welding mode for making short and regular welded sections. This is generally achieved by setting the spot time and the pause time.

SINERGIA

Modalità di funzionamento del generatore che permette di regolare contemporaneamente la velocità del filo, la tensione d'arco e l'eventuale frequenza di pulsazione tramite una sola manopola. La relazione tra i vari parametri è fissata opportunamente in fase di progetto.

SYNERGY

Operating mode of the generator used to adjust the speed of the wire, the arc voltage and the possible pulsation frequency at the same time through a single knob. The relationship between the various parameters is set appropriately during design.

PAC Taglio al Plasma

Plasma Cutting



Il plasma è un gas fortemente ionizzato, ovvero composto da particelle cariche, e quindi conduttore di corrente elettrica. Esso può essere ottenuto facendo passare il gas da ionizzare, in genere aria compressa o gas inerte, attraverso un arco elettrico generato all'interno di una strozzatura meccanica. In questo modo la concentrazione delle particelle cariche che si formano aumenta notevolmente, di conseguenza aumenta l'effetto termico e si innalza la temperatura. Il gas ad alta temperatura tende ad espandersi e, attraversando la strozzatura, acquisisce una velocità molto elevata: **si ottiene un dardo di cariche ad energia concentrata, utilizzabile per tagliare i metalli.**

Si può realizzare un impianto di taglio al plasma utilizzando un generatore di corrente con caratteristiche opportune, una sorgente di gas ed una torcia che convoglia il gas in un ugello al cui interno viene generato l'arco elettrico.

Plasma is a strongly ionized gas, namely composed of charged particles, and therefore it is an electric current conductor. It can be obtained by making the gas to be ionized, usually compressed air or inert gas, pass through an electric arc generated inside a mechanical bottleneck.

This way, the concentration of charged particles is increased considerably, and consequently the thermal effect and the temperature rise. The high temperature gas tends to expand and, through the bottleneck, acquires a very high speed: **a dart of concentrated energy charges is obtained, which can be used to cut metals.**

A plasma cutting plant can be made using a current generator with suitable characteristics, a gas source and a torch which conveys the gas into a nozzle inside which the electric arc is generated.

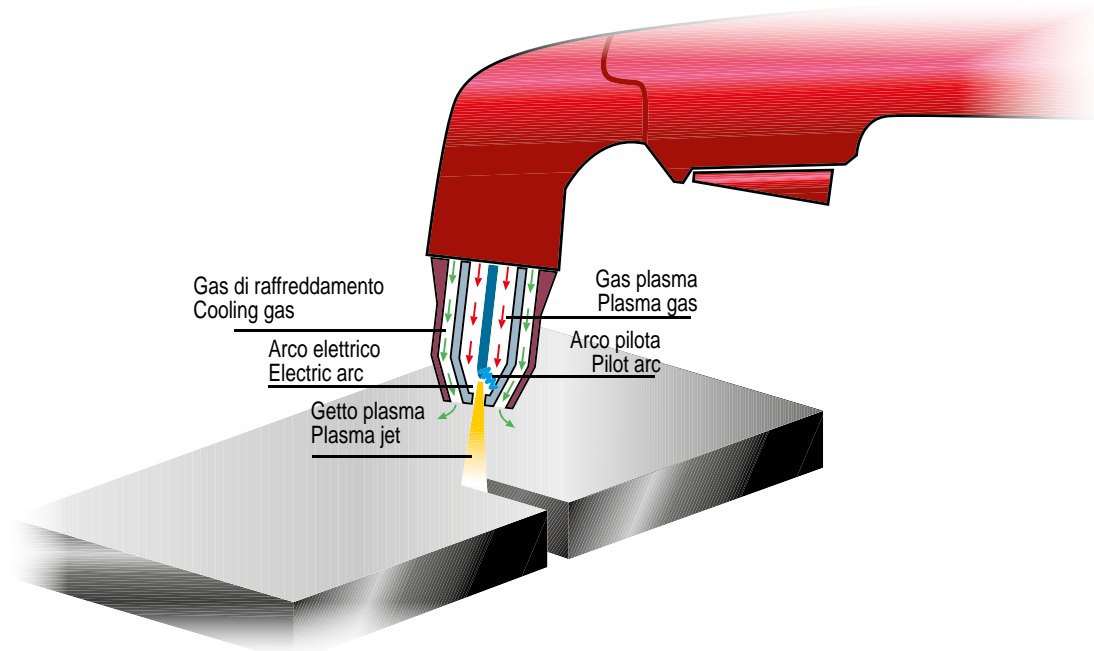

E' preferibile iniziare il taglio dell'oggetto metallico a partire dal bordo libero del materiale.

Se è necessario partire "dal pieno", è opportuno realizzare prima un foro con una tecnica alternativa al taglio plasma.

La velocità esecutiva del taglio dipende dallo spessore e dal tipo di metallo. Se la velocità è molto bassa, è difficile ottenere un taglio di qualità.

La velocità di taglio dipende da molte variabili e può solo essere valutata in modo approssimativo in caso di applicazioni manuali.

A titolo indicativo si riportano due tabelle di corrispondenze tra velocità di taglio espressa in centimetri al minuto, metallo e spessore da tagliare, corrente e diametro dell'ugello.

It is preferable to start cutting the metal object starting from the free edge of the material.

If it is necessary to start "from inside", a hole should be made first with an alternative technique to plasma cutting.

The cutting speed depends on the thickness and the type of metal. If the speed is very low, it is difficult to get a quality cut.

The cutting speed depends on many variables and can only be estimated roughly in case of manual applications.

Below are two tables of correspondences between cutting speed expressed in centimeters per minute, metal and thickness to be cut, current and diameter of the nozzle, provided purely for guidance.

INNESCO SENZA ALTA FREQUENZA

L'elettrodo è mobile, il flusso del gas lo stacca dall'ugello e la differenza di potenziale tra elettrodo ed ugello provoca la scintilla d'innescò dell'arco pilota. L'arco pilota viene poi trasferito al pezzo ed inizia il processo di taglio.

STRIKING WITHOUT HIGH FREQUENCY

The electrode is movable, the gas flow detaches it from the nozzle and the potential difference between the electrode and the nozzle causes the priming spark of the pilot arc. The pilot arc is then transferred to the piece and starts the cutting process.

INNESCO AD ALTA FREQUENZA

L'arco pilota tra elettrodo ed ugello si innesca grazie alla scintilla provocata da un dispositivo che genera una serie di impulsi elettrici a tensione elevata, successivamente l'arco viene trasferito al pezzo ed inizia il processo di taglio.

HIGH FREQUENCY STRIKING

The pilot arc between the electrode and the nozzle is primed thanks to the spark caused by a device that generates a series of high voltage electric pulses; the arc is then transferred to the piece and starts the cutting process.

TAGLIO DI QUALITÀ

E' un taglio che consente una separazione netta, con bordi regolari e quasi perpendicolari alla superficie dell'oggetto tagliato. In genere si ottiene se la velocità di avanzamento del taglio è costante e non inferiore a 30-40 centimetri al minuto. **Per ottenere un taglio di qualità è necessario scegliere un impianto PLASMA che possa separare uno spessore massimo sensibilmente superiore a quello di lavoro.**

QUALITY CUTTING

It allows a sharp separation, with regular edges almost perpendicular to the surface of the cut object. Generally, it is obtained if the cutting speed is constant and not less than 30-40 centimeters per minute. **To obtain a quality cut it is necessary to choose a PLASMA system that can separate a maximum thickness that is significantly bigger than the working one.**

SEPARAZIONE MASSIMA

E' il massimo spessore che si riesce a separare. Il valore indicato nella documentazione commerciale è generalmente riferito al ferro e non corrisponde ad un taglio di qualità.

MAXIMUM SEPARATION

It is the maximum thickness that can be separated. The value specified in the commercial documentation is generally referred to iron and does not correspond to a quality cut.

TAGLIO A CONTATTO

Tecnica di taglio in cui l'ugello è a contatto con il pezzo da tagliare. Si usa in genere per spessori non superiori ai 5/6 millimetri.

CONTACT CUTTING

Cutting technique in which the nozzle touches with the piece to be cut. It is generally used for thicknesses not bigger than 5/6 mm

TAGLIO CON DISTANZIALE

Tecnica di taglio in cui l'ugello è mantenuto distante dal pezzo da tagliare tramite l'uso di opportuni distanziatori che si montano all'estremità della torcia. Consente gli spessori di taglio massimi raggiungibili dall'impianto usato.

CUTTING WITH SPACER

Cutting technique in which the nozzle is kept away from the piece to be cut by means of suitable spacers that are mounted at the end of the torch. It allows the maximum cutting thicknesses that can be reached by the system used.



MMA

TIG

MIG

PAC

MMA

TIG

MIG

PAC

CAR BODY REPAIR

Accessori Accessories

Tech

SPOT Saldatura a resistenza

Resistance welding



La saldatura a resistenza sfrutta il calore che si genera nel punto di contatto tra due parti metalliche quando per tale punto passa una corrente elettrica. Il calore sviluppato dalla corrente è proporzionale alla **resistenza elettrica** dei conduttori. Nel punto di contatto tra due oggetti metallici la resistenza è maggiore di quella del metallo, pertanto il passaggio di corrente provoca il surriscaldamento della zona vicina al contatto e, se la corrente è sufficientemente elevata, si arriva alla fusione e quindi alla saldatura dei due oggetti. Il **controllo della saldatura** avviene tramite la **regolazione dell'intensità di corrente e del tempo** durante il quale la corrente attraversa il punto di contatto.

Resistance welding exploits the heat generated at the point of contact between two metal parts when electric current passes through it. The heat developed by the current is proportional to the **electrical resistance** of the conductors. At the point of contact between two metal objects, resistance is greater than that of the metal; therefore, the current being conducted causes overheating in the area close to the contact and, if it is high enough, there is melting and the two objects are welded. **Welding** is controlled by **adjusting the current intensity** and the time during which the current flows through the contact point.

PUNTATURA (SPOT)

La puntatura è un'applicazione di saldatura a resistenza in cui le due parti da saldare sono costituite da due lamiere sovrapposte. Gli elettrodi sono solidali a due bracci meccanici che permettono di stringere con una forza opportuna le lamiere nel momento del passaggio di corrente. Si realizza così l'unione delle lamiere in uno o più punti. Il sistema che manovra i due bracci meccanici può essere di vario genere. Per le applicazioni in **carrozzeria** si usa in genere una pinza pneumatica che può essere facilmente impugnata da un operatore in modo da accedere alle diverse parti del telaio dell'automobile.

SPOT WELDING

Spot welding is a resistance welding application, in which the two parts to be welded are two overlapping sheets. The integral electrodes have two mechanical arms that tighten the sheets with a suitable force when the current is conducted. The sheets are thus joined in one or more spots. The system that maneuvers the two mechanical arms can be of various kinds. For **bodywork** applications, a pneumatic gripper is generally used which can be easily grasped by an operator in order to access the different parts of the car chassis.

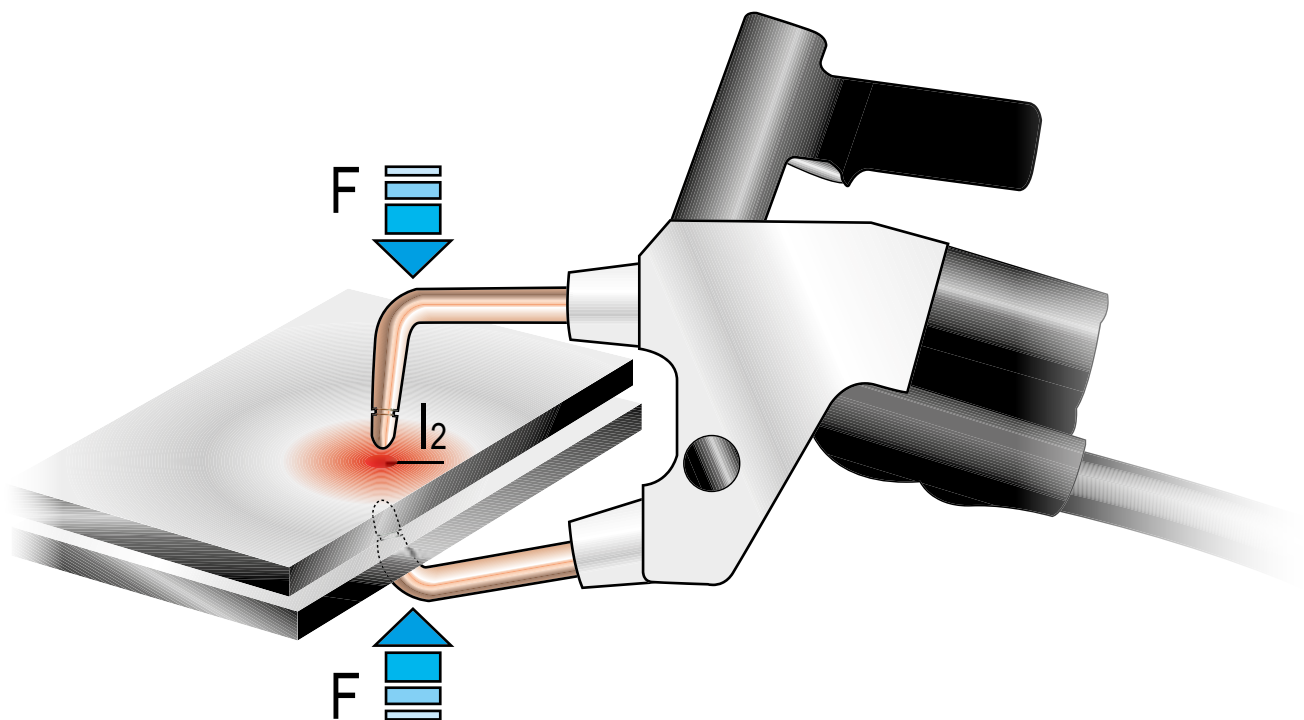

STUD Saldatura di perni



Stud welding

SALDATURA DI PERNI (STUD)

La saldatura di perni è un'applicazione di saldatura in cui le due parti da saldare sono costituite da un perno e da una lamiera metallica. Il perno viene dapprima meccanicamente fissato per un'estremità sulla punta di una pistola opportuna che costituisce il primo elettrodo; l'estremità libera del perno viene appoggiata quindi sul foglio di lamiera a cui è stato collegato il secondo elettrodo.

La forza di contatto è regolata manualmente dall'operatore che impugna la pistola e spinge il perno sulla lamiera, oppure da un sistema a molla. La pressione di un pulsante abilita il passaggio di corrente e la saldatura del perno alla lamiera.

Si saldano in genere **perni di acciaio** con sistemi di saldatura a resistenza ad **energia diretta**.

Per la saldatura di **perni di alluminio** si preferisce l'uso di sistemi ad **energia immagazzinata a scarica capacitiva**: in questo caso la saldatura è più propriamente definita ad arco e non a resistenza ed in effetti è osservabile la scintilla tra perno e lamiera nell'istante del passaggio di corrente.

La saldatura di perni è un'applicazione ricorrente in molti ambiti di carpenteria metallica ed in particolare in **carrozzeria**: i perni saldati sulla lamiera danneggiata di un'automobile, ne consentono il tiraggio e il ripristino alla condizione originale.

STUD WELDING

Stud welding is a welding application, in which the two parts to be welded are a stud and a metal sheet.

An end of the stud is first mechanically fixed to the tip of a suitable gun which constitutes the first electrode; the free end of the stud is then placed on the metal sheet to which the second electrode has been connected.

The contact force is adjusted manually by the operator who grips the gun and pushes the stud onto the sheet, or by a spring system.

Pressing a button enables the current to be conducted and the stud to be welded to the sheet.

In general, **steel studs** are welded with **direct energy** resistance welding systems.

For welding **aluminum studs**, it is preferred to use **capacitive discharge stored energy systems**: in this case welding is more precisely defined arc and not resistance welding, and in fact the spark between stud and sheet can be observed on the moment the current is conducted.

Stud welding is a frequent application in many areas of metal carpentry and in particular in **bodywork**: the studs welded on the damaged sheet of a car allow it to be drawn and restored to the original condition.

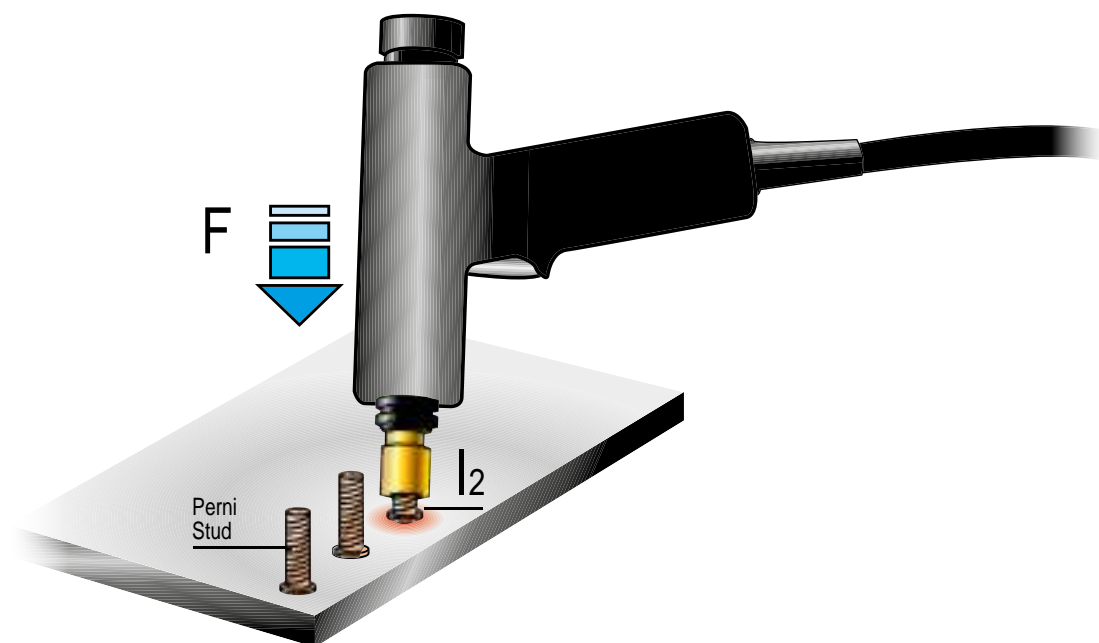

MMA

TIG

MIG

PAC

MMA

TIG

MIG

PAC

CAR BODY REPAIR

Accessori Accessories

Tech



yellow energy

DECA S.p.A.

Strada dei Censiti, 10
Zona Industriale Rovereta
47891 Falciano - Repubblica di San Marino

Tel. da/from Italy **0549 910711**
from other Countries **+378 0549 910711**

Fax da/from Italy **0549 908360**
from other Countries **+378 0549 908360**

Documento non contrattuale. DECA si riserva il diritto di modificare senza preavviso le specifiche dei suoi prodotti.
Document not contractual. DECA reserves the right to modify the specifications of the machines without prior notice.

AA0157-02

design: www.ramstudio.com

www.decaweld.com

